

Biogas and Energy Production by Utilization of Different Agricultural Wastes

Attila Meggyes

Budapest University of Technology and Economics
Department of Energy Engineering
Műegyetem rkp. 3, H-1111 Budapest, Hungary
e-mail: meggyes@energia.bme.hu

Valéria Nagy

University of Szeged, Faculty of Engineering
Moszkvai krt. 9, H-6725 Szeged, Hungary
e-mail: valinagy78@mk.u-szeged.hu

Abstract: Sustainable agricultural development and increasing the rate of renewable energy sources have become an economic issue after Hungary joined the EU. Under the present economic conditions the private sector cannot solve in its complexity the problems of environment protection and energy from its own sources. The paper introduces biogas production and utilization methods that are suitable for providing continuous operation of existing biogas plants and also for determining the parameters of establishing biogas plants. Experimental variants (mixtures of liquid pig manure and plant additives) were developed to produce biogas and intensify biogas yield, and then gas engine tests were done for the energy utilization. The eco-energy system can be built up by taking into consideration the specific local conditions. It does not require any change or transformation of agricultural structure. The system can be expanded by the utilization of other organic materials, so it supports efficient operation. Furthermore, it can be the pillar of energy independence of rural life, because during the establishing of the eco-energy system, ecological aspects are taken into consideration, which makes this system sustainable. Waste disposal requirements can be integrated, too. We created a complex biogas production and utilization system by developing variants, so that both the energy and the waste disposal goals can be achieved together. This system was presented as an alternative agricultural system for an animal farm.

Keywords: biogas production; biogas utilization; energy; complex system; environment; waste disposal

1 Introduction

Producing and utilizing renewable energy – both in a global and a national context – is necessitated by the synergistic effect of climate change and the long term, continuous price rise of fossil fuels. The main reasons for the spread of renewable energy sources are to increase the security of the energy supply or, in optimal case, to realize total energy independence. Our paper deals with production and utilization of biogas for energy. The importance of biogas is, in addition to energy aspects, justified environmentally by EU requirements and by economic considerations, because conservation of the state of our environment and efficient, economically satisfying energy demands can be solved by the harmonized application of traditional and renewable energy sources. It is necessary to create a complex biogas production and utilization system for energy while we focus on the environment and waste disposal. The centre of the system must be integrated waste-management and environmental energy utilization. The subject of this research is: how to meet collectively the energy and waste disposal requirements without transformation of the system.

2 Research Task, Object

This paper presents the complexity of the production and utilization of biogas. The research work was done at the Budapest University of Technology and Economics, Department of Energy Engineering, and at Szolnok University College, Technical and Machinery Department. In the course of our research work, we supposed that there is an energy-producing and energy-utilizing technology which can be suitable for the circumstances and initial conditions. The objective of the research task was to support the approach that it is necessary to examine the biogas producing and utilizing technological processes together as a complex system. It is needed to analyze these, considering that the principle of the complex optimization focuses just on the environment and waste disposal. The tasks performed during the research were:

- Proving with experiments the yield-increasing and quality improving effects of different kinds of plant additives added to pig manure in the fermenters (mesophylic bioreactors).
- Testing the utilization of biogases from different kinds of liquid pig manure and additives for energy gaining in gas engines, with particular regard to the emission.

Environment-friendly utilization of organic pollution materials and energy production can be realized together by biogas production and utilization. We showed through a specific example how to develop a pig farm to a steady energy supply and waste disposal unit by treatment of liquid pig manure in a pig farm.

3 Scientific Background

3.1 Biomass-based Energy Production – Biogas

Energy is a complex system; hence, energy-production and energy-conversion require systemic thinking, for which firstly a change of aspect is necessary. The primary view-point is to satisfy the energy demands with the lowest possible stress on the environment. Furthermore, ecological thinking should prevail increasingly during the planning and operating of the different kinds of technical equipment and facilities [1]. It can be determined that the biomass-based energy system can mean the necessary transformation of the energy structure. Researchers of several domestic and foreign universities and research institutes have specialized in the feasibility of biogas production from different kinds of biomass. Braun [2] examined the types and degradation features of basic material, while Llabrés and Müller et al. and Borbély [3, 4, 22] examined the anaerobe degradation of different kinds of substrates based on liquid pig manure and examined the output-increasing effect of pre-treatment processes and the kinetics of cellulose. Gunaseelan, Lehtomäki et al, Mata et al and Panichnumsin et al [5-8] studied the fermentation of manures and different kinds of plant additives. In their experiments, the positive synergistic effects created the possibility of higher methane productivity. They established that the top of sugar-beet doping causes higher hydrogen-sulphide content in biogas and that increasing the ratio of additives causes a decrease methane productivity. Houdková et al built a laboratory fermentation unit for the experimental determination of biogas production [9]. Kalyuzhnyi et al [10] studied the integrated mechanical, biological and physical-chemical treatment of liquid pig manure. He created a mathematical model of anaerobe decomposition and revealed and described the principal controller factors with numerical experiments. Meanwhile Misra [23] also emphasizes the elaboration of a practical model for empirical validation.

3.2 Utilization of Biogas in Gas Engines

Biogas is a gaseous matter similar to natural gas and can be utilised in many ways. Biogas has different combustion and compositional characteristics compared to natural gas, so it needs a different system of preconditions compared to the combustion of natural gas [11]. One way to use biogas is its utilization in internal combustion engines. The basic national research institutes for combustion engineering examined the feasibility of the combustion of low heat value gases with inert content – among them biogases, the technical and economic effect of their application, and the combustion properties of biogas [12, 13]. In the 1960s, Sándor [14] undertook experiments to verify the necessity of gas-engines. Neyeloff-Gunkel [15] specialized in the modelling and simulation of the

combustion of biogas. Porpatham [16] examined how bio-fuel from biomass can be applied as a fuel in internal combustion engines. They tested the operation and the emission of a one-cylinder, four-stroke engine fuelled by natural gas, biogas and their mixtures.

Huang-Crookes [17] did experiments on a one-cylinder, four-stroke, spark ignited engine at constant speed, using increasing compression-ratios, given CO₂ content (37.5%) and air access ratio (0.97). The increasing compression-ratio caused intensively increasing NO_x and HC emission. Crookes [18] made further tests with changing CO₂ content. He determined that increasing the CO₂ content results in a decrease in NO_x emission, which can be due to decreasing combustion speed and combustion peak-temperature.

4 Methods and Results of the Research Work

Through the simultaneous presentation of the research into biogas production and utilization, we wished to present the connection between agriculture and energy; we looked at the waste-problem of pig-farms with a few hundred pigs and the possibility of the treatment of liquid pig manure and, further, to the feasibility of building a stable energy-production unit.

The results of our research work, undertaken at the Mezőtúr Campus of Szolnok College, demonstrate the quantity and composition of the generated biogas via fermentation of liquid pig-manure and different kinds of additives. The results reveal further how the fermenters can be operated to produce the proper quantity of biogas with a composition that complies with added utilization potentialities in plants with similar technology.

In the course of biogas utilization in spark-ignited internal combustion engines, information can be collected as to the effects of biogases from different kinds of basic materials and additives on the operation of gas-engines, considering particularly the emission.

4.1 Methods and Results Concerning the Biogas Production Researches

At the Mezőtúr Campus of Szolnok College, we undertook biogas producing experiments based on liquid pig-manure to develop variants for intensifying biogas yield. The task performed during the research were:

- Planning of the biogas producing experiments, and the preparation of an applied fermentation technology and unit.
- Constructing and continuously developing the instruments for the experiments.

- Undertaking biogas producing experiments for the energy utilization of biogas.
- Evaluating the results (quantity, composition, energy content, etc.) of the biogas producing experiments.

We created 30 experimental variants using different kinds of plant additives to produce biogas based on liquid pig manure. The dry matter content of the liquid pig manure was 4%, and our experiments lasted 43-50 days. The increase did not influence quality (methane content), but methane stability depended on the additives. *Table 1* shows the variants with which biogas can potentially be made in the proper quantity and quality for energy production.

Table 1
Chosen variants

<i>signs of variants</i>	<i>pig manure</i>	<i>bacteria</i>	<i>sweet sorghum press residue</i>	<i>fruit marc</i> (different ratio)	<i>maize marc</i>	<i>average biogas production</i> [dm ³ /kg organic dry matter]	<i>methane content</i> [%]
<i>Variant 1</i>	+	-	+	-	-	417	52.0-59.0
<i>Variant 2</i>	+	+	-	-	+	589	52.2-59.5
<i>Variant 3</i>	+	-	-	+ (50%)	-	512	62.5-74.9
<i>Variant 4</i>	+	-	-	+ (25%)	-	453	66.8-77.1

We have developed variants to produce biogases beneficial not only from the point of view of energy but also from that of waste disposal as well. The concrete conclusions of our biogas production experiments can be summarized as below:

- Some additives (fruit marc) have acidic pH, so they can be applied only under certain conditions and in limited quantities in biogas systems.
- The additives which contain volatile organic acids can be yield-increasing, because of the biomass containing 50% (Variants 3) and 25% (Variants 4) alcohol waste (fruit marc), which means a potential biogas producing method which takes into consideration both the quantity of the produced biogas and the methane content of biogas.
- The applied variants can provide favourable conditions for producing biogas, and, simultaneously, waste disposal can also be realized via biogas-production.
- Maize-marc and fruit-marc as additives have the effect of an increased methane production, coupled with a stable gas composition.
- The methane production of the given variants satisfies the conditions of utilization, and so the heat engines can operate properly.

4.2 Methods and Results of Biogas Utilization Researches

We undertook research work in the György Jendrassik Heat Engineering Laboratory at the Budapest University of Technology and Economics, Department of Energy Engineering. The objective of the gas engine tests was to get to know how biogases – as the different kind of experimental variants – influence the operation of gas engines. The experimental gas engine is not a special biogas engine but rather a conventional natural gas engine.

Figure 1 shows the schematic diagram of the engine test set-up. The main parts of the test engine are:

- 24.6 kW, 4 cylinder Wisconsin Motors Continental TM27 type gas engine
- 26.4 kW, 4 pole Marelli CX IM B3 180M type asynchronous dynamometer
- controller box (starter button, mode switch, locking switch etc.)
- indication system
- emission analyzer
- data collecting system

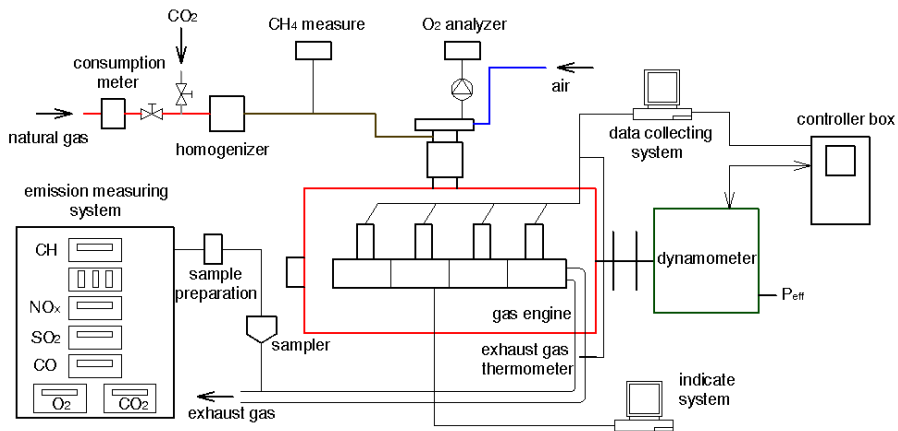

Figure 1

The engine test set-up

The tasks performed during the research were:

- Planning of biogas utilization tests and choosing the applied technology.
- Undertaking biogas utilization tests with the experimental gas engine set-up at disposal.
- Processing the results of the biogas utilization tests.

In the course of choosing the applied fuel to operate heat engines we must take into consideration, in every case, that environmental science, which has an interdisciplinary character, also involves certain areas of the energy. One way to use biogas is in internal combustion engines. The objective of our research work is to examine what effects biogases have on the operation of gas engines and to choose biogases via which both the operation of the gas engine is suitable and the utilization and waste disposal can be realized together.

Out of the biogases produced for the experiments, we chose – considering the yield and the methane content – some optimal appearing biogases (Variants 1, 2, 3, 4). We represented the composition of the biogases with substitute gases (a variable mixture of natural gas and carbon-dioxide). Natural gas contains ~96% methane [21], but the composition of biogases is methane and carbon-dioxide; in addition, they have a changing composition. During our engine laboratory tests, we produced a gas mixture with constant composition almost similar to a biogas variety and we undertook tests with them because variable composition complicates the tests and makes generally valid conclusions uncertain. Ignition time and ignition advance were not changed. During our experiments, we assured that the engine was able to perform with different ranges of biogas composition. Thus, it can designate all the possible ranges, but in the case of a variable composition of biogas, it is more difficult to perform the tests.

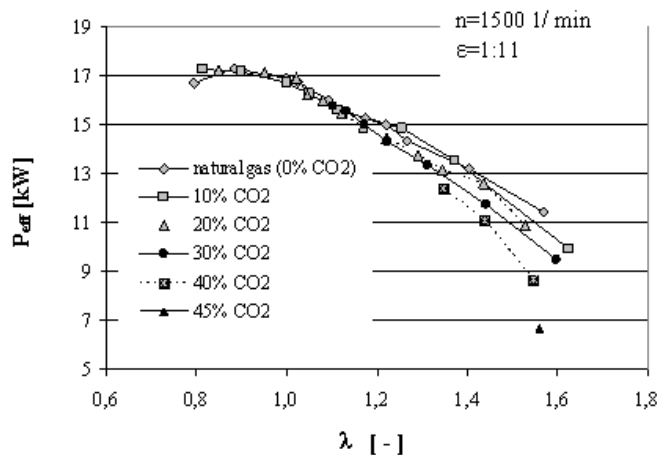

Figure 2
Effective performance

Figure 2 shows the effective performance diagrams. If the engine is fuelled with gas mixtures (with 10-20% carbon-dioxide content) in the range of $\lambda=0.8-1.1$ air access ratios, it is able to transmit almost the same values of the effective performance as in the case of operation with natural gas. If the engine is fuelled with gas mixtures with 30% carbon-dioxide content in the range of $\lambda=1.1-1.2$ air

access ratios (the gaseous consumption increased though), it is able to produce values of the effective performance similar to natural gas operation. In the range of $\lambda > 1.2$ air access, the values of the effective performance coefficient fall below the values of natural gas due to the influence of the increase in carbon-dioxide. As the methane content of the biogas decreases, the effective performance values decrease (by 10-15%). We dealt with the operation of the engine in our previous paper in details [19].

Fig. 3 – fig. 6 show the partial results of measurement. Our results were analyzed for energy generation and waste disposal aspects.

In the figure below (*Fig. 3*) it can be seen that in the case of $\lambda > 1.1$ air access ratios, the cooling effect of the surplus air results in lower NO_x emission. The engine operation with increasing carbon-dioxide content (and thus decreasing methane content) of the gas mixture – on account of delaying of the combustion and the cooling effect of carbon-dioxide – results in a further decrease.

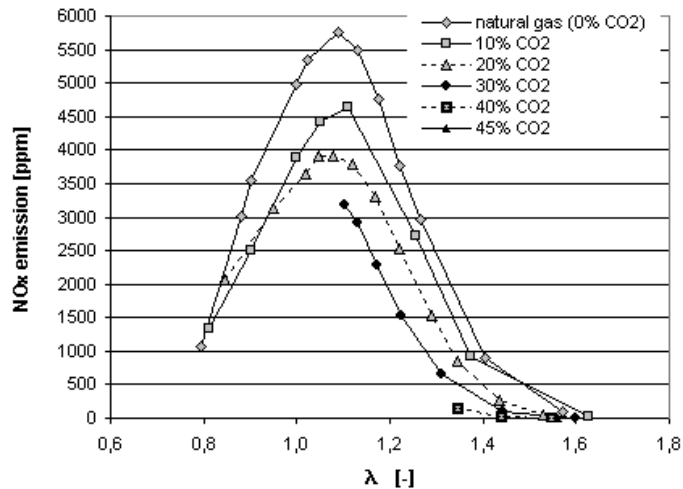

Figure 3
NO_x emission

However, while the methane content of the biogas decreases, the carbon-dioxide content increases at the same time. This means that excess feeding from the biogas with lower methane content is needed for just the same quantity of methane. The quantity of carbon-dioxide fed into the engine with the fuel increases, which appears also in the exhaust gas, producing significantly increased CO_2 (*Fig. 4*).

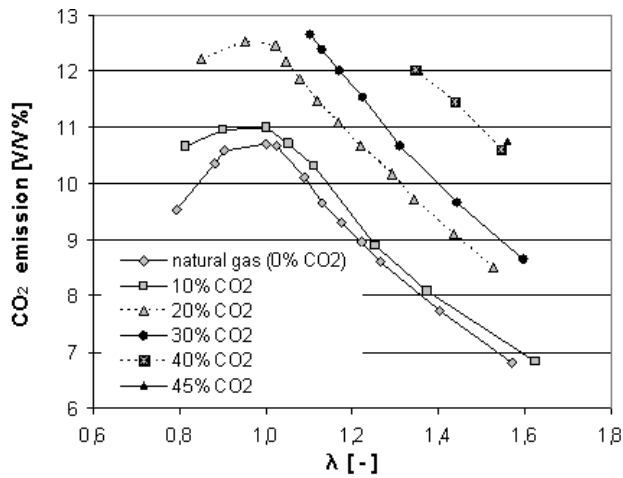

Figure 4
CO₂ emission

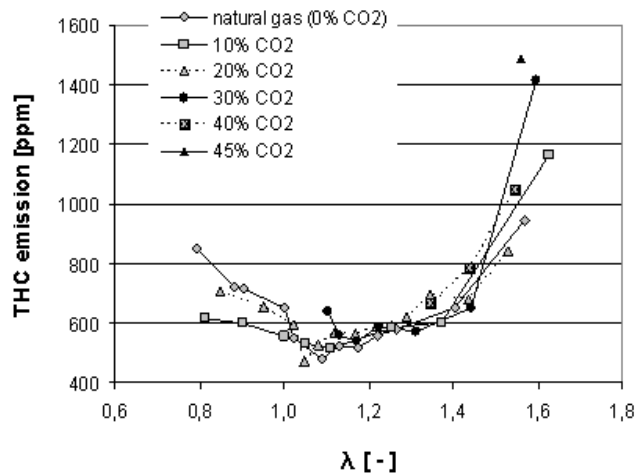

Figure 5
THC emission

With an increase in the carbon-dioxide content of the applied energy carrier, the combustion conditions worsen, which causes a higher unburned hydrocarbons content in the exhausted gas. There is no significant difference between the operation of gas engines fed with natural gas and with gas mixtures with a higher carbon-monoxide content (with lower methane content) in the range of $\lambda=1.2-1.5$ air access ratio (Fig. 5).

It is noticeable in the following figure (Fig. 6), that in case of $\lambda < 1.0$ air access ratios, the CO emission increases by leaps and bounds, which can be explained by the production of a richer mixture. However, in range of $\lambda = 1.1-1.4(1.5)$ air access ratios, CO emissions – independently of the carbon-dioxide content of the gas mixture – are stabilized at much lower values. In the case of $\lambda > 1.4(1.5)$ air access factors, the drag on the combustion results in increased CO emission. Thus, concerning CO emission, it can be unambiguously determined that for a traditional gas engine operated with a gas mixture with low methane content, there is no effect on CO emission if the gas engine is operated permanently within the range of $\lambda = 1.1-1.4$ air access factors.

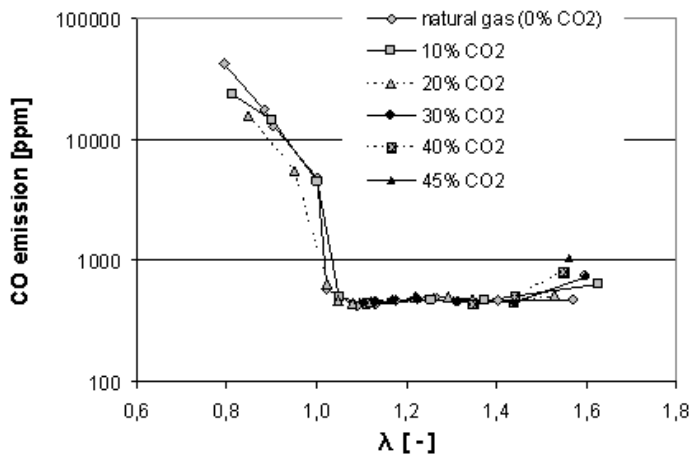

Figure 6
CO emission

The results of tests done with biogases with different methane contents show that biogas with 60-72% methane content – as the result of developed variants – can be combusted in a traditional gas engine. When the methane content of the biogas decreases, the operating range of the gas engines narrows and will shift towards the higher air access ratio (1.2-1.6), the effective performance values decrease (by 10-15%), and the efficiency slightly (by 2-4%) worsens.

We determined by emission tests that the utilization of biogases generated on the basis of our variants results in lesser emission in the operation range of $\lambda = 1.2-1.6$ of the gas engines. The NO_x emission decreases as much as (20-50%), while the CO and THC emissions practically do not change. The increased CO_2 emission can be explained by the CO_2 content of the applied biogas, but the CO_2 content of the biogas is of biological origin.

The concrete conclusions of our biogas utilization tests can be summarized as below:

- The engine, operated with biogas with 70% methane content within the range of $\lambda=1.1-1.2$ air access ratio (though with increased gas consumption) is able to produce values of effective performance similar to natural gas operation.
- At higher air access ratios, the effective output and the efficiency would decrease significantly, due to the influence of increasing carbon-dioxide.
- In the course of the operation of the gas engines, in the case of lean burn, the higher CO_2 content of different biogases positively influences the NO_x emission.
- The increasing CO_2 emission is due to the CO_2 content of the biogas. On the other hand, the CO and THC emissions rise suddenly at insufficient air access or at large air-excess.
- A continuous operation in the range of $\lambda=1.2-1.6$ air access ratios results in lower emission in total.

5 Complex Energy Production and Waste Disposal

The production and utilization of renewable energy sources are justified not only by energy, political, environmental and competitive aspects, but by rural development aspects as well. Therefore, in our paper we present research results which promise to help in these areas and to provide for the smooth and effective operation of already existing and operating energy producing establishments, as well as waste disposal biogas facilities. The merit of the research work is that we have verified the necessity of the complex ecological aspects via complex biogas production experiments and via biogas utilization tests in gas engines. Based on the results of our research, it can be stated, that:

- Through anaerobe fermentation of biomass, produced from basic material and plant additives, a suitable quantity and quality of biogas can be generated for utilization in gas engines.
- When applying the above demonstrated variants, the favourable conditions for producing a potential renewable energy source – biogas – at workshop level can be created, and waste disposal can be realized simultaneously.

5.1 Complex Biogas Utilization System

We created a complex biogas production and utilization system by developing variants so that both the energy and the environmental goals can be achieved. For the sake of an optimal solution, it is necessary to analyze the two objective functions together, considering that the principle of the complex optimization focuses just on the environmentally-friendly energy utilization. If the quantity and/or quality of the input material necessary for developing variants cannot be provided, the energy output can decrease and waste disposal can be overshadowed too. In *Fig. 7* the sketch model of an energy cycle adapted to the biogas producing and utilizing system can be seen, and we present this system as alternative agricultural system of an animal farm.

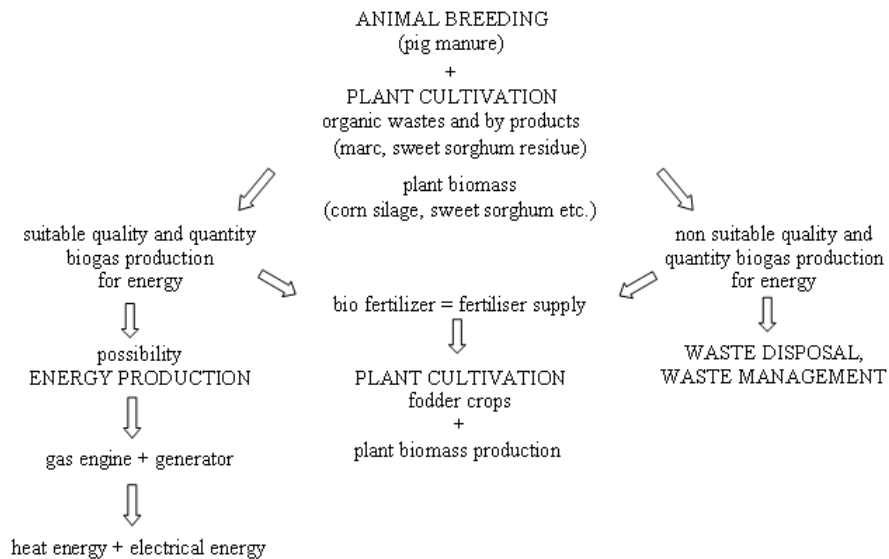

Figure 7
Diagram of biogas producing and utilizing farm system

The centre of the complex system is the integrated waste-management and environmental energy-utilization. Its advantages are local and global environmental results, energy production independent of external influences, and a better “population retention capacity” for rural areas, as well as a near optimum solution both ecologically and economically. It also realizes the achievement of being a closed circuit system.

5.2 Practical Application of the Results

We supposed that there are 500-800 pigs on a pig farm, and therefore the quantity of liquid pig manure is 1277.5 ton/year. The pig (liquid) manure is not enough alone to produce the necessary biogas quantity and fuel quality for the energy supply needs of the farm, so it is necessary to use different kinds of agricultural by-products and wastes, and it is necessary to add a biomass plant. Since biogas plants are in continuous operation, it is necessary to provide a yield enhancing organic matter in the annual production cycle. We applied agricultural by-products and wastes as organic additives during the development of the experimental variants. On the farm, the disposal options for organic wastes played an important role in selection alongside enhanced biogas yield (methane yield). *Table 2* contains the annual quantity of pig liquid manure and organic additives for developing the experimental variants.

Table 2
“Energy” from organic wastes

<i>organic wastes for energy production</i>	<i>quantity of organic wastes [ton/year]</i>	<i>average quantity of produced methane [m³/day]</i>
pig (liquid) manure	1277.5	Σ 130.7*
fruit marc	219	
maize marc	43.8	
sweet sorghum residue	18.25	
corn silage	25.55	

* 170-250 m³ biogas

Most of the organic wastes in the table can be produced on the farm and are available outside the harvest period (August-November) as well, and so the operation of system can be provided for by agricultural wastes which are stored. But other organic matter (organic waste) is available through agriculture or can be obtained from the alcohol industry.

Based on the above, it can be stated that all organic matter can be biodegraded in the biogas plant, but that due to aspects of biogas production we should consider for energy production only organic matter which biodegrade rapidly and is available in sufficient quantity in the farm.

The available capacity on the farm is: 2 fermenters 115 m³ volume/fermenter (diameter 7 m, height 3 m) and utilization of approx. 1600 ton/year multi-component biomass, which is proper ~2.22 kg organic dry matter content daily per fermenter m³. The low heating value of the producing biogas can be determined from methane yield based on dry matter content, so the biogas production and its methane content: energy value also increases if the yield and methane ratio increase. Based on the above, ~130.7 m³ methane is produced per day. 1 m³

normal state methane has $\sim 34.014 \text{ MJ/Nm}^3$ low heating value. In the case of Micro F22 AP type gas engine, 18 hours operation time, $\sim 86\%$ engine loading, $\sim 130 \text{ m}^3$ methane/day ($170\text{-}250 \text{ m}^3$ biogas per day) is needed. It can produce $\sim 27.3 \text{ kW}$ heat power and $\sim 14.5 \text{ kW}$ electric power considering that the efficiency of the machine units is $\sim 90\%$. Some electric and heat energy can be used for individual needs (e.g. heating, tempering of the fermenters, etc.) of the farm and the fermenting system. The heat energy consumption is 30% , while the electric energy consumption is 5% from the produced energy. The surplus electricity produced can be used in the electric network while the use of surplus heat is a continuous problem and can be a practical and obstructing factor, but it can be used for heating in winter or for drying, e.g. alfalfa and/or grain in summer time. Based on the above, it can be determined that the farm – in an optimal case – can be energy independent.

The nutrient demand of sweet sorghum, corn and other fodder can be provided by fermentation residue (bio fertilizer). As the application of fermentation residue can help to take the natural cycle, on the one hand it has valuable nutrients which improve the soil structure, and on the other hand we do not produce waste.

The experimental variants that produce biogas with smaller methane content serve the principles of sustainable development via aspects of organic waste management and disposal. We all know about the environmental impacts that threaten our environment, and we also know that all responsible persons must do something to prevent this damage and harm [20].

Conclusions

A complex biogas production and utilization system was created by developing experimental biogas variants, and in such a way both the energy and the environmental goals can be achieved together, as the applied variants can provide favourable conditions for the production and the utilization of biogas. The methane content of biogas satisfies the conditions of utilization so that the heat engines can operate properly. Simultaneously, waste disposal can also be realized. In the interest of a near optimal solution, it is necessary to analyze the production and utilization functions together, considering that the principle of the complex optimization focuses just on the environmental-friendly energy utilization. Thus, if the quantity and/or quality of the input material necessary for developing variants cannot be provided, the energy output can decrease and waste disposal can be overshadowed too.

References

- [1] Nemcsics, Á.: Technical Ecology (A műszaki ökológia), *Természetbúvár*, Hungary, Vol. 1 (2003) p. 37
- [2] Braun, R: Biogas-Methangärung organischer Abfallstoffe, Springer Wien (1982)

- [3] Llabrés-Luengo, P., Mata-Alvarez, J.: Influence of Temperature, Buffer, Composition and Straw Particle Length on the Anaerobic Digestion of Wheat Straw-Pig Manure Mixtures, *Resources, Conservation and Recycling*, Volume 1, Issue 1 (1988) pp. 27-37
- [4] Müller, J. et al.: Thermische, chemische und biochemische Desintegrationsverfahren, *Korresp Abwasser*, 50 (2003) pp. 796-804
- [5] Gunaseelan, V. N.: Anaerobic Digestion of Biomass for Methane Production: A Review, *Biomass & Bioenergy*, 13 (1997) 1-2, pp. 83-114
- [6] Lehtomäki, A., Huttunen, S., Rintala, J. A.: Laboratory Investigations on Co-Digestion of Energy Crops and Crop Residues with Cow Manure for Methane Production, *Resources, Conservation and Recycling* (2006) Nov, pp. 1-19
- [7] Mata-Alvarez, J., Mace, S., Llabres, P.: Anaerobic Digestion of Organic Solid Wastes, *Biores Technol*, 74 (2000), pp. 3-16
- [8] Panichnumsin, P., Nopharatana, A., Ahring, B., Chaiprasert, P.: Production of Methane by Co-Digestion of Cassava Pulp with Various Concentration of Pig manure, *Biomass and Bioenergy*, Vol. 34 (2010) Issue 8, pp. 1117-1124
- [9] Houdková, L., Borán, J., Pěček, J., Šumpela, P.: Biogas – A Renewable Source of Energy, *Thermal Science*, Vol. 12 (2008) No. 4, pp. 27-33
- [10] Kalyuzhnyi, S. et al.: Integrated Mechanical, Biological and Physico-Chemical Treatment of Liquid Manure, *Water Science and Technology*, 41 (2000) 12, pp. 175-182
- [11] Kapros T.: Biogas Combustion in Industrial Equipment (Biogáztüzelés az ipari berendezésekben), *Biogáz-előállítás és -felhasználás*, Hungary, Vol. 1 (2009) 1, pp. 38-41
- [12] Kerek I., Riba D.: Development of Biogas Combustion Equipment (Biogáz tüzelőberendezések fejlesztése), XXXV. Ipari Szeminárium, Miskolc, Hungary, 1999
- [13] Selmecci J.: Experiments on Inert Gas Combustion (Inert tartalmú gázok eltüzelésével kapcsolatos kísérleti tevékenység), XXXIV. Ipari Szeminárium, Miskolc, Hungary, 1998
- [14] Sándor I.: The Agriculture as an Energy Source for Engine Fuel (A mezőgazdaság, mint motorikus gázenergiaforrás), *Járművek, Mezőgazdasági Gépek*, Hungary, Vol. 12, No. 3 (1965) pp. 107-109
- [15] Neyeloff, S., Gunkel, W.: Performance of a CFR Engine Burning Simulated Anaerobic Digester's Gas, ASAE Publication (1981) 2, pp. 324-329

- [16] Porpatham, E., Ramesh, A., Nagalingam, B.: Investigations on the Use of Biogas and LPG in a Spark Ignition Engine, PRITHVI International conference on environment friendly transportation, Trivandrum, India, 24-25 February, 2005
- [17] Huang, J., Crookes, R. J.: Assessment of Simulated Biogas as a Fuel for Spark Ignition Engine, *Fuel*, Volume 77 (1998) 15, pp. 1793-1801
- [18] Crookes, R. J.: Comparative Bio-Fuel Performance in Internal Combustion Engines, *Biomass and Bioenergy*, Volume 30 (2006) 5, pp. 461-468
- [19] Meggyes A., Nagy V.: Effect of the Biogases Produced by Different Kinds of Recipes on the Operation of Gas Engines, *Proceedings*, 9th International Conference on Heat Engines and Environmental Protection, Balatonfüred, Hungary, 2009, pp. 71-76
- [20] Nagy, V.: Effect of the Biogas Producing Methods on the Operation of the Gas Engine Considering Emission (A biogáz előállítási eljárások hatása a gázmotorok üzemére, különös tekintettel a károsanyag kibocsátásra), Ph.D thesis, Budapest University of Technology and Economics, Budapest, Hungary, 2010
- [21] Kovács V. B., Meggyes A.: Energetic Utilization of Pyrolysis Gases in IC Engine, *Acta Polytechnica Hungarica*, Vol. 6, No. 4 (2009) pp. 157-172
- [22] Borbély É.: The Kinetics of Cellulose Grafting with Vinyl Acetate Monomer, *Acta Polytechnica Hungarica*, Vol. 2, No. 2 (2005) pp. 67-76
- [23] Misra S.: An Approach for the Empirical Validation of Software Complexity Measures, *Acta Polytechnica Hungarica*, Vol. 8, No. 2 (2011) pp. 141-160