

A Stochastic Approach to Fuzzy Control

Károly Nagy*, **Szabolcs Divéki***, **Péter Odry***, **Matija Sokola****,
Vladimir Vujičić***

* Subotica Tech - College of Applied Sciences, Marka Oreškovića 16
24000 Subotica, Serbia, e-mail: [nagyk, diveki, odry]@vts.su.ac.rs

** The School of Higher Technical Professional Education in Novi Sad
Školska 1, 21000 Novi Sad, Serbia, e-mail: sokola@vtsns.edu.rs

*** Department/Institute for Power, Electronics and Communications
Engineering, Faculty of Technical Sciences, Trg Dositeja Obradovića 6,
21000 Novi Sad, Serbia, e-mail: vujicicv@uns.ac.rs

Abstract: The paper presents the utilization of low-resolution data for control purposes. The control is based on fuzzy logic, with the deployment of stochastic digital low-resolution time arrays. Every control decision contains a degree of imprecision, being derived from measured low-resolution data. The imprecision is eliminated by stochastic noise superimposed during the data gathering, while the negative effects of noise are suppressed both by the fuzzy nature of the decision-making process and by the energy inertia in the controlled object. The proposed stochastic fuzzy control is extremely fast, robust and so simple that it practically does not need a microprocessor. This approach is validated by a simulation of holding upright an inverse pendulum.

Keywords: fuzzy control; fuzzy inference systems; approximate reasoning; fuzzification; alpha-cuts; stochastic

1 Introduction

Fuzzy logic and fuzzy reasoning have been shown to be a very effective approach in various control applications, especially when the control problem is multi-dimensional; when the plant model is unknown or time-varying; and/or when the feedback measured data are unreliable or unavailable [1]. In many control approaches, the measured feedback is extensively processed in order to eliminate measurement uncertainties and other errors, and such a processed feedback signal is used in the chosen control algorithm. Such processing of high-resolution data either puts further demands on processing capabilities or forces the reduction of the refresh rate of the controller output [2]. Hence, the utilization of accurate high-resolution data may become unsuitable for the control of fast multi-variable processes.

Representing analogue variables by a time-array of 1-bit binary signals has been researched for various purposes. Direct-stream digital, based on sigma-delta modulation, is employed in audio-technology for sound recording, and pulse-width modulation is widely used in power electronics, pulse position modulation, pulse density modulation, etc. All of these methods prove that it is possible to establish a strong correlation between an analogue value and a sufficiently long binary time array. Low-bit digital time arrays have also been researched in metrology and successfully utilized for fast low-resolution measurements [3], [4], [5], [6], [7], [8]. One of the key components is the introduction of stochastic dither, superimposed onto the input signal. Even 2-bit devices, with very coarse instantaneous measurements, will provide extremely accurate results [6]. In similar fashion, dither is utilised in [9] to enhance the quality of feedback signals for the fuzzy logic controller. The drawback is that high precision cannot be achieved by short time arrays of low-resolution data [3], [6], thus using such signals will lead to an imprecision in fast control decisions. However, a new control decision is arriving very soon. Can we use the ideas of making reliable overall systems from unreliable elements as proposed in [10] and utilise them to generate fast control decisions from imprecise low-resolution data, knowing that the control actions will, in time, converge to a stable state?

Over the last several decades, fuzzy logic and fuzzy reasoning have been shown to work effectively with imprecise data ([6], [10]). How to combine the stochastic signal processing with fuzzy control? Papers of Zadeh [11] and Goodman *et al.* [12], [13], [14] show theoretical possibilities of connecting Boolean algebra, conditional algebra, stochastic concepts and fuzzy logic in complementary ways. For control applications, fuzzy logic operations that include comparison of two or more membership functions are needed. How to incorporate the stochastic dimension that is inherently carried by the low-resolution nature of the feedback signal? One possible method is α -cuts [3], [14], [15], [16], which are used to best represent a certain feature of a set, i.e. to form a relationship between fuzzy sets and crisp sets. The stochastic feature is ensured by employing a randomly varying level of α in every control cycle. In this way it is possible to generate binary time-arrays, which can be compared in order to execute some fuzzy logic operations (for instance min, max operations).

The contribution of this paper is to show that it is possible to realize a simple controller in which probability theory and fuzzy logic complement each other, as theoretically suggested in [11]. In this case, the classical binary logic is utilised in a spirit of fuzzy logic philosophy. The link between these two logics is provided by a novel combination of stochastic principles and α -cuts. The resulting 1-bit time arrays are processed by classical Boolean algebra, necessary for individual control decisions. This approach is suitable for some control applications and offers some groundwork ideas for further development.

The proposed system differs from both classical fuzzy control and various improvements of fuzzy control [2], [9], [17]-[25]. A major aspect of difference is

the utilisation of very raw feedback signals for control. Although many control systems try to find the optimal output control signal in every decision cycle, the proposed system makes individual control decisions in such a way not to worsen the controlled variable. This means that we accept that the controlled object cannot be always brought to the required state within only a few control cycles - we are just driving it in an acceptable direction. Nevertheless, the overall control within a sufficient time interval converges towards an accurate control.

The paper is organized as follows: Section 2 presents the theory of using the α -cut sets approach for control purposes; Section 3 discusses the fuzzy sets and utilization of low-resolution signals for control of the inverse pendulum in the upright position and shows the simulation results.

2 α -cut Set as a Control Element

2.1 Decomposition Principles – the Model for Obtaining a Stochastic Array from a Membership Function

In classical fuzzy control, a membership function is an analogue value between 0 and 1 [1]. In the stochastic approach proposed in this paper, this analogue value is substituted by a time array of 1-bit signals (zeroes and ones) in such a way that the analogue value representing the membership function is the probability of appearance of value 1 in the 1-bit time array.

The model for obtaining such an array can be illustrated by the decomposition principle: An α -cut set is a discrete (crisp) set made up of members whose membership is greater than α [1], [3], [15], [16]:

$$A_\alpha = \{x \mid \mu_A(x) > \alpha\}, \alpha \in [0,1] \quad (1)$$

Theoretically, the original continuous fuzzy set A can be decomposed into an infinite number of crisp α -cut sets.

The fuzzy set can be represented as a union of discrete sets expressed as:

$$A = \bigcup_{\alpha} \alpha A_\alpha, \alpha \in [0,1] \quad (2)$$

which means that the membership function is calculated using:

$$\mu_A(x) = \sup_{\alpha \in [0,1]} [\alpha \wedge \chi_{A_\alpha}(x)] \quad (3)$$

where $\chi_{A_\alpha}(x)$ is the characteristic function of the α -cut set A_α . This function represents a crisp discrete set, and hence the value of the membership level is 1 for

all its elements. When, for a chosen value of α , intersection with function $\chi_{A_\alpha}(x)$ is calculated, function αA_α is obtained. When αA_α functions for all α values from 0 to 1 are calculated and subjected to sup (finding the maximum) operation, a union operation is practically performed. In this way the original fuzzy set can be constructed.

In a similar fashion, it is possible to determine the membership function to a fuzzy set for individual elements if there is a finite number N of α -cut sets (N is also the number of samples of the feedback signal), but such that α is a random number of uniform probability distribution in the interval 0 to 1 ([11], [12], [13], [14]).

$$\lim_{N \rightarrow \infty} \frac{1}{N} \sum_{i=1}^N \chi_{A_\alpha}(x)_i = \mu_A(x), \quad \alpha \in [0,1] \quad (4)$$

This means that the characteristic function $\chi_{A_\alpha}(x)$ can be considered as a random variable, which assumes value 1 with probability $\mu_A(x)$, otherwise it assumes value 0. When α is lower than $\mu_A(x)$, then $\chi_{A_\alpha}(x) = 1$.

$$\chi_{A_\alpha}(x) = \begin{cases} 1 & \alpha < \mu_A(x) \\ 0 & \alpha \geq \mu_A(x) \end{cases} \quad (5)$$

Let us assume that instead of a fuzzy set there is an array of α -cut sets of the fuzzy set, such that α is a random variable with a uniform distribution $\alpha \in [0,1]$. Depending on the value of α , one element can be a member of an α -cut set or it can be outside the α -cut set, thus giving the required time array of zeroes and ones.

Signals obtained by low-bit quantization carry two pieces of information – the accurate value and the random error. The accurate value is extracted as an average of the array. The random error cannot be determined in every element of the array, but the random error for a whole array can be estimated ([5], [6], [7], [8], [26], [27]).

2.2 Comparison of Low-Resolution Signals – Minimum, Maximum, AND, OR Operations

In control systems of “if-then” type, the “if” part of the rule is formed from the membership functions of the input variables. The conditions and rules are formed in a shape of a logic expression, which contains the membership functions of the input variables [1]. If the input variables, at every digital tact cycle, can assume values of 1 and 0 only, then various operations on those variables can be executed within one cycle – extremely fast.

The actual elements of n input stochastic signal arrays can be considered as random variables, which assume value 1 with probabilities p_1, p_2, \dots, p_n . If those random variables are uncorrelated, classical AND, OR, NAND NOR logic operations can be performed. However, any correlation between variables will change the meaning of logic operations.

It is possible to form logic terms from the elements of stochastic arrays. Knowing the probability of assuming the value of 1 in individual stochastic arrays and whether the variables are correlated or not, it is possible to determine the probability of the logic term output assuming the value of 1. In this way, the output stochastic array of similar properties as the two input arrays is obtained.

If the input arrays are uncorrelated, classical logic operations are valid. However, if every input variable is compared with the same α value of the α -cut set, the resulting operations become minimum, maximum or difference operations.

2.2.1 Uncorrelated Random Variables

Let us consider two input variables and at least two fuzzy sets. The membership function of the first input variable to the first fuzzy set is $\mu_A(x)$, while the membership function of the second input variable to the second fuzzy set is $\mu_B(\omega)$ where $0 \leq \mu_A(x), \mu_B(\omega) \leq 1$; α_1 and α_2 are independent random variables of uniform probability distribution $0 \leq \alpha_1, \alpha_2 \leq 1$, utilised for determining the α -cut sets of the corresponding fuzzy sets.

2.3 Logic Operations on Corresponding Elements of the Arrays which Describe Membership Functions $\mu_A(x)$ and $\mu_B(\omega)$

Based on the α -cut set models, an event belongs to the α -cut set if $\alpha_1 < \mu_A(x)$, while if $\alpha_1 \geq \mu_A(x)$ the event doesn't belong. (Ψ_1 is the actual element of the first stochastic array). Event $\Psi_1 = 1$ has the probability $P(\Psi_1 = 1) = \alpha_1$, while the probability of the event $\Psi_1 = 0$ is $P(\Psi_1 = 0) = 1 - \alpha_1$. Similarly, the second array has features $P(\Psi_2 = 1) = \alpha_2$ and $P(\Psi_2 = 0) = 1 - \alpha_2$.

If the input variables are uncorrelated, the probabilities of possible combined events are:

$$P(\Psi_1 = 1, \Psi_2 = 1) = \alpha_1 \cdot \alpha_2 \quad (6)$$

$$P(\Psi_1 = 1, \Psi_2 = 0) = \alpha_1 \cdot (1 - \alpha_2) \quad (7)$$

$$P(\Psi_1 = 0, \Psi_2 = 1) = (1 - \alpha_1) \cdot \alpha_2 \quad (8)$$

$$P(\Psi_1 = 0, \Psi_2 = 0) = (1 - \alpha_1) \cdot (1 - \alpha_2) \quad (9)$$

If the four above expressions are added, their combined probability equals 1, confirming that a complete field of possible events is described.

Equation (6) represents AND operation, while the combination of (7), (8) and (9) represents OR operation.

2.3.1 Minimum and Maximum Operations

Let us consider two membership functions $\mu_A(x)$ and $\mu_B(\omega)$ and assume $\mu_A(x) > \mu_B(\omega)$. If those two signals are compared with the same random number α , the following states can be obtained:

$$\mu_A(x) > \alpha \wedge \mu_B(\omega) > \alpha \quad (10)$$

$$\mu_A(x) > \alpha \wedge \mu_B(\omega) < \alpha \quad (11)$$

$$\mu_A(x) < \alpha \wedge \mu_B(\omega) < \alpha \quad (12)$$

but the event

$$\mu_A(x) < \alpha \wedge \mu_B(\omega) > \alpha \quad (13)$$

is an impossible event.

Performing logic AND operation on such random variables, the lowest value of membership functions can be obtained, since all membership functions can be greater than α if the lowest function is greater than α . The output array is equivalent to the array of lowest membership function,

$$(\mu_B(\omega) > \alpha) \Rightarrow (\mu_A(x) > \alpha) \quad (14)$$

The minimum operation on the two membership functions is performed by AND logic operation:

$$\min(\mu_A(x), \mu_B(\omega)) = \mu_A(x) \wedge \mu_B(\omega) \quad (15)$$

By OR operation the largest of the two compared membership functions are chosen. Consequently, if one the largest membership function is greater than the random number α , then at least one of the compared functions is larger than α .

The maximum operation is performed by the logic OR operation:

$$\max(\mu_A(x), \mu_B(\omega)) = \mu_A(x) \vee \mu_B(\omega) \quad (16)$$

It is also possible to calculate the difference between two membership functions:

$$\mu_A(x) - \mu_B(\omega) = \mu_A(x) \wedge \overline{\mu_B(\omega)} \quad (17)$$

Proof: for

$$\begin{aligned} \alpha > \mu_A(x) & \quad \Psi_A = 0 \quad \Psi_B = 0 \\ \mu_A(x) > \alpha > \mu_B(\omega) & \quad \Psi_A = 1 \quad \Psi_B = 0 \\ \alpha < \mu_B(\omega) & \quad \Psi_A = 1 \quad \Psi_B = 1 \end{aligned} \quad (18)$$

The purpose of the above MIN, MAX and DIF operations is to reduce the amount of calculations on stochastic arrays so that very simple logic circuits can be used instead of a microprocessor. This will enormously increase the speed of sampling and processing, resulting in the possibility that the control output is being updated in every processor cycle.

2.3.2 Choosing the Membership Functions to Fuzzy Sets in the Form of Stochastic Arrays

Let us consider an arbitrary trapezoidal shaped fuzzy set and the random number α (dashed line), Figure 2 [1], [28].

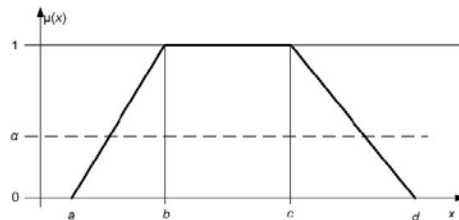

Figure 2

A trapezoidal fuzzy set and the random number α

The input variable x belongs to the α -cut set if: $\mu_A(x) > \alpha$. In order to determine the α -cut set interval of the input variable, it is necessary to determine in which part of the membership function the input variable is greater than the random variable α . The intersection points are determined as:

$$\alpha = \frac{x-a}{b-a} \Rightarrow x = a + \alpha(b-a) \quad (19)$$

$$\alpha = \frac{d-x}{d-c} \Rightarrow x = d - \alpha(d-c) \quad (20)$$

Therefore, the condition for belonging to an α -cut set is:

$$[a + \alpha(b-a)] < x \wedge x < [d - \alpha(d-c)] \quad (21)$$

This can be rearranged as:

$$a < x - \alpha(b-a) \wedge x + \alpha(d-c) < d \quad (22)$$

i.e.

$$\frac{b+a}{2} < x - \alpha(b-a) + \frac{b-a}{2} \wedge x + \alpha(d-c) - \frac{d-c}{2} < \frac{d+c}{2} \quad (23)$$

As α is a random number between 0 and 1, terms $\alpha(b-a)$ and $\alpha(d-c)$ are random numbers of uniform distribution.

When the sum of the measured variable and a random number is compared with a decision trigger level, this is a process very similar to the stochastic additive A/D conversion against decision levels PO_1 and PO_2 ([5], [6], [7], [8]). If the random dithers $h_1(t)$ and $h_2(t)$ are added to the measured analogue signal x , then the digitizing process is defined by:

$$PO_1 < x - h_1(t) \wedge x + h_2(t) < PO_2 \quad (24)$$

$$h_1(t) = \alpha(b-a) - \frac{b-a}{2} \quad (25)$$

$$h_2(t) = \alpha(d-c) - \frac{d-c}{2} \quad (26)$$

As in this case $(b-a) = (d-c)$, it follows that $h_1(t) = h_2(t) = h(t)$.

3 Utilization of Low-Resolution Signals for Control

To illustrate the feasibility of the proposed control system, the classic example of holding the inverse pendulum in the upright position was chosen. Similarly, [2], [9], [17] – [25] use the inverse pendulum in order to validate their proposed fuzzy controllers.

The authors have investigated a practical application of the proposed stochastic fuzzy control system for the very fast and accurate control of arc welding. In such applications, problems with fast-changing plant parameters and the presence of very high levels of noise are pronounced. On the other hand, actuation is very fast: the PWM modulation of welding current is performed by transistors operating in switching mode at frequencies up to 100 kHz. Such requirements can be met by the proposed low-resolution control system. The practical implementation that is under development employs analogue summation of analogue dither and analogue measurement signal, followed by 1-bit digitalization.

3.1 The Control Problem of Inverse Pendulum

The simplest one degree-of-freedom (DOF) inverse pendulum system on a trolley, shown in Figure 3, is considered. The actuator is either a single-level or multiple-level impulse actuator, acting in bidirectional bang-bang mode, which may be described as push/do_nothing/pull (F_+ , 0, F_-) type action. In order to control the pendulum, it is necessary to monitor/measure and control two variables: θ - the angle of the pendulum from the vertical axis and ω - the angular velocity of the pendulum, similarly to [9].

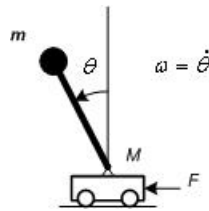

Figure 3

Illustration of the inverse pendulum with one DOF

3.2 Control Utilising One-Level Actuator

The first control system is designed for an actuator which has only one level of possible output in each direction - single level bidirectional bang-bang. The control system operates at a higher frequency, in order to accomplish the control task with a moderate actuator force, even in cases of unfavourable initial conditions or strong disturbances.

3.2.1 Definitions of Fuzzy Sets and Membership Functions

As both measured variables are single-dimensional, the fuzzy sets can be defined as both fuzzy numbers and fuzzy intervals. Three fuzzy sets ("negative", "zero" and "positive") are chosen within the measured angle interval, but with triangular rather than trapezoidal membership functions. Hence values b and c from Figure 2 are identical, $b=c$. Furthermore, the target value for the control system in this case is the vertical position, i.e. zero, thus $\theta b = \theta c = 0$. In such a case, the membership functions for the pendulum **angle control** are defined as follows:

$$\text{For negative angle } \Theta_{NN}, \mu_{\Theta_{NN}}(\theta) = \begin{cases} 1 & \text{if } \theta \leq \theta a \\ \frac{\theta}{\theta a} & \text{if } \theta a < \theta < 0 \\ 0 & \text{if } \theta \geq 0 \end{cases} \quad (27)$$

$$\text{For "zero" angle } \Theta_{ZZ}, \quad \mu_{\Theta_{ZZ}}(\theta) = \begin{cases} 0 & \text{if } \theta \leq \theta a \\ \frac{\theta a - \theta}{\theta d - \theta} & \text{if } \theta a < \theta \leq 0 \\ \frac{\theta a}{\theta d - \theta} & \text{if } 0 < \theta < \theta d \\ 0 & \text{if } \theta \geq \theta d \end{cases} \quad (28)$$

$$\text{For positive angle } \Theta_{PP}, \quad \mu_{\Theta_{PP}}(\theta) = \begin{cases} 0 & \text{if } \theta \leq 0 \\ \frac{\theta d - \theta}{\theta d} & \text{if } 0 < \theta < \theta d \\ 1 & \text{if } \theta \geq \theta d \end{cases} \quad (29)$$

These membership functions are shown in Figure 4:

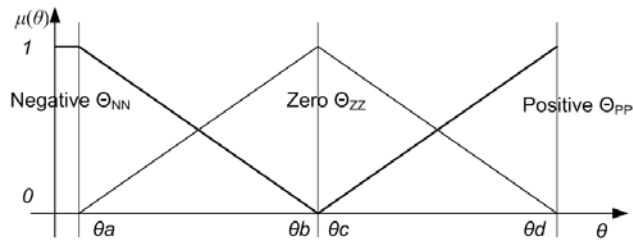

Figure 4

Fuzzy sets of the pendulum angle

The fuzzy sets and the membership functions for the **control of angular velocity** are defined in the same way; only the lower threshold velocity is denoted ωa and the upper threshold is denoted ωd . With the identical control target of resting (zero velocity) in the upright position, equations for negative, "zero" and positive angular velocity (Ω_{NN} , Ω_{ZZ} and Ω_{PP} respectively), are similar to (27)-(29), and the membership functions are as shown in Figure 5.

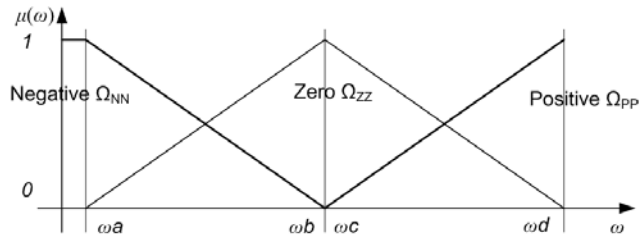

Figure 5

Fuzzy sets of pendulum angular velocity

3.2.2 Fuzzy Rules for One-Level Actuator

The control problem of holding the inverse pendulum upright is defined by rules of fuzzy decision as follows:

- R1: If $\theta > 0$ and $\omega > 0$, then $F = F_+$,
 R2: If $\theta > 0$ and $\omega = 0$, then $F = F_+$,
 R3: If $\theta > 0$ and $\omega < 0$, then $F = 0$,
 R4: If $\theta = 0$ and $\omega > 0$, then $F = F_+$,
 R5: If $\theta = 0$ and $\omega = 0$, then $F = 0$,
 R6: If $\theta = 0$ and $\omega < 0$, then $F = F_-$,
 R7: If $\theta < 0$ and $\omega > 0$, then $F = 0$,
 R8: If $\theta < 0$ and $\omega = 0$, then $F = F_-$,
 R9: If $\theta < 0$ and $\omega < 0$, then $F = F_-$.

where: F_- is the constant force in negative direction and F_+ is the constant force in positive direction.

On the basis of the above fuzzy logic rules, the logic circuit with only 12 logic gates, shown in Figure 6, can be constructed.

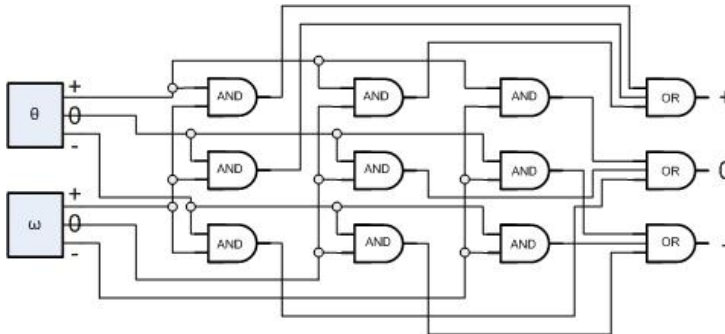

Figure 6

Arithmetic-logic scheme of fuzzy control for a single-level actuator

3.2.3 Simulation Results of the Control Utilizing One-Level Actuator

The above fuzzy rules have been faithfully modelled into a simulation of the inverse pendulum system. Although such simple control hardware can be extremely fast, a very moderate frequency of 1 kHz has been chosen for the simulations. The physical parameters are: trolley mass $M=1$ kg, pendulum mass $m=0.1$ kg, pendulum height $h=1$ m, available actuator force $F= \pm 16$ N.

The results of the first two seconds of bringing out-of-balance pendulum into a stable upright position are shown in Figure 7. The initial conditions are quite challenging: the pendulum is 0.3 radians out of balance, falling further with 0.4 rad/s angular velocity.

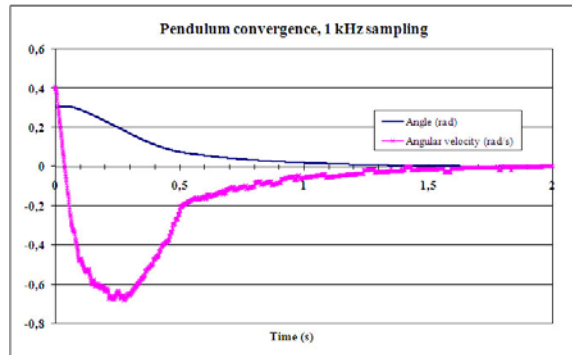

a) angle and angular velocity during the simulation

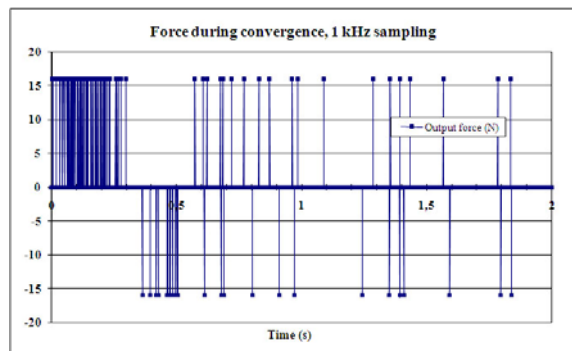

b) actuator force during the simulation

Figure 7

Aligning the inverse pendulum into the upright position, sampling 1 kHz, 16N actuator

The simulated values of the pendulum angle and its angular velocity are shown in Figure 7a, and it can be seen that the control system is very effective. It stops the pendulum falling further after less than 0.1 seconds (angular velocity becoming negative), brings it very close to the upright position in less than 1.5 seconds without overshooting, and keeps it stable afterwards. The actuator force, shown in Figure 7b, displays a lot of activity in the first 0.35 s, then moderate activity for the next second, and then is required to act just occasionally afterwards. The stochastic nature of the controller can be observed, at around 1.83 seconds, and although the pendulum is upright and not moving away, there is one positive impulse and then immediately one negative impulse of the actuator. This is a waste of energy: two burst were applied when none was really needed.

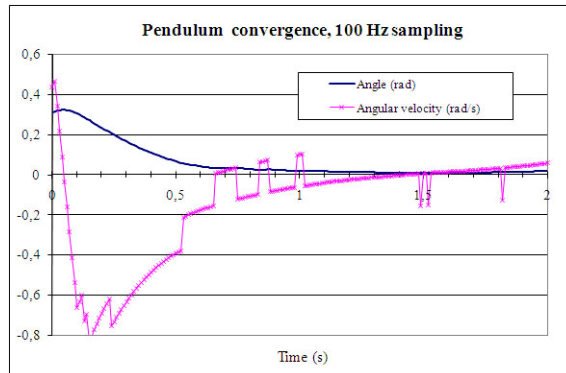

a) angle and angular velocity during the simulation

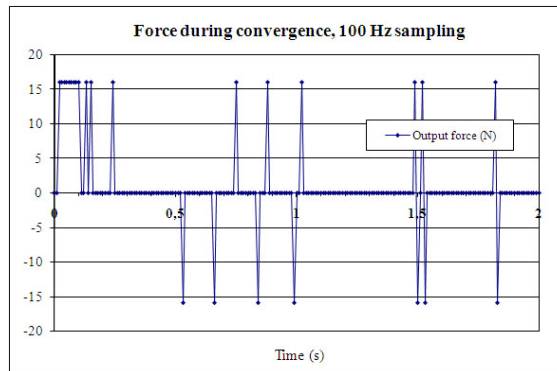

b) actuator force during the simulation

Figure 8

Aligning the inverse pendulum into the upright position, sampling 100 Hz

The required force impulses are further investigated in 10 simulation runs; with identical initial conditions, the stochastic nature of the controller makes every simulation slightly different. Overall, only around 60% of the actuator force output is used for lifting the pendulum from unbalanced to the upright position, while around 40% of the actions is wasted due to the stochastic nature of the controller.

The effects of reducing the sampling frequency were investigated next. Figure 8 shows the position and the angular velocity for the sampling frequency of 100 Hz, with an original actuator force of 16 N. It can be seen that the system is still performing well, converging to a near upright position within less than 2 seconds and holding it upright afterwards. However, higher fluctuations of angular velocity can be observed in a steady state. These fluctuations are more pronounced because the duration of every actuator action is 10 times longer, and the energy

inserted during one control cycle is now 10 times larger. Further reductions in operating frequency further increases velocity fluctuations, thus compromising the accuracy of tracking and eventually would result in an unstable system.

3.2.4 Comparison with High-Resolution Fuzzy Control

A wide comparison of the proposed control approach based on low-resolution (LR) data against the fuzzy control based on high-resolution (HR) data has been performed. Many simulations runs have been performed, at different sampling frequencies and with different actuator forces. Following on from the discussion in the previous paragraph, the expected deviations in velocity response increase with a reduction in sampling frequency; therefore the results at 100 Hz are shown in Figure 9. Responses of the pendulum angle and its angular velocity obtained with the HR control system are depicted in bold lines, while the thin lines are responses of the proposed LR stochastic fuzzy controller, for three randomly chosen simulation runs.

It is interesting to note that simulation runs of the LR control differ from each other, due to the stochastic dither. This confirms our initial idea that individual control decisions do not need to be always the best in every time instant, but the proposed control method will provide the overall convergence of the controlled plant towards the required state.

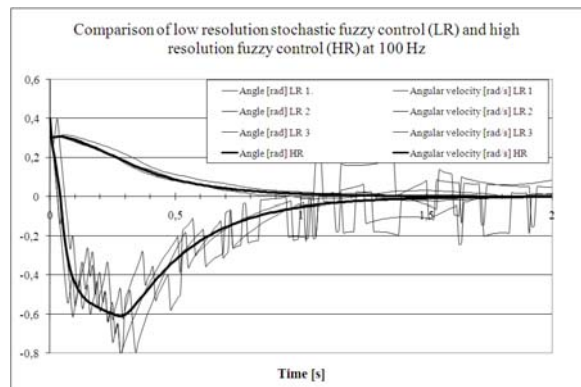

Figure 9

Comparison of high-resolution and low-resolution (3 simulation runs) control, sampling 100 Hz

3.3 Control Utilising a Three-Level Actuator

From the results shown in Section 2.3.2, as well as from many conducted simulations with different sampling frequencies and/or actuator force levels, a collision of three features can be observed:

- a low control sampling rate is beneficial for the reduction of imprecision in individual control decisions, but it increases the fluctuations around the steady-state position,
- a lower actuator force is good for minimising the total force impulses but it limits the maximum system capabilities,
- aggregate force input increases with both too high and too low control sampling rates.

In order to optimise, rather than compromise between sampling frequency, tracking accuracy, actuator available force and energy efficiency, a three-level actuator is implemented. The actuator output force has three digital levels (*low, medium, high*), in two directions, so that it can assume seven possible levels.

The control strategy is adapted so that it operates in two modes of control:

- 1) fine control, when both angular position and angular velocity are within their threshold limits, or
- 2) forceful control, when at least one of the controlled variables is outside the threshold limits.

The fuzzy rules are adapted so that only the low-level force is applied in the fine control mode, while medium and high force levels can be applied in the forceful control mode.

3.3.1 Definitions of Fuzzy Sets and Membership Functions

The three fuzzy sets for the forceful **angle control** are identical as before, as given by (27)-(29) and shown in Figure 4. When the angle is within the fine regulation thresholds, $\theta \in (\theta_{af}, \theta_{df})$, then the three fuzzy sets for fine regulation are negative fine angle Θ_N , "zero" fine angle Θ_Z and positive fine angle Θ_P . All six fuzzy membership functions are shown in Figure 10.

Using an equivalent approach, the fuzzy sets for **angular velocity control** are defined for forceful control and for fine control, as shown in Figure 11.

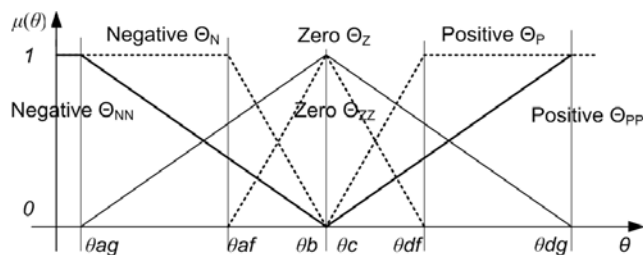

Figure 10

Fuzzy sets of the pendulum angle for forceful/fine control

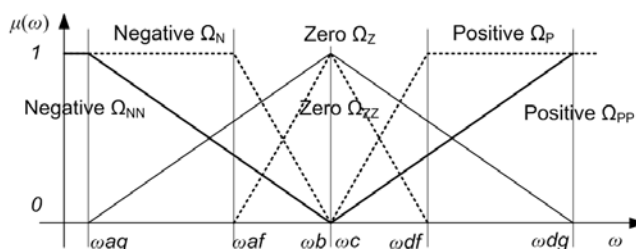

Figure 11

Fuzzy sets of pendulum angular velocity

3.3.2 Fuzzy Rules for a Three-Level Actuator

The rules of fuzzy decision are defined as follows:

In the fine control mode, when $\theta \in (\theta_{af}, \theta_{df})$ and $\omega \in (\omega_{af}, \omega_{df})$, fuzzy rules are:

- | | | | | |
|-------------|-----------------|--------------------|--------------------|------|
| R11: | If $\theta > 0$ | and $\omega > 0$, | then $F = + low$, | |
| R12: | If $\theta > 0$ | and $\omega = 0$, | then $F = + low$, | |
| R13: | If $\theta > 0$ | and $\omega < 0$, | then $F = 0$, | |
| R14: | If $\theta = 0$ | and $\omega > 0$, | then $F = + low$, | |
| R15: | If $\theta = 0$ | and $\omega = 0$, | then $F = 0$, | (31) |
| R16: | If $\theta = 0$ | and $\omega < 0$, | then $F = - low$, | |
| R17: | If $\theta < 0$ | and $\omega > 0$, | then $F = 0$, | |
| R18: | If $\theta < 0$ | and $\omega = 0$, | then $F = - low$, | |
| R19: | If $\theta < 0$ | and $\omega < 0$, | then $F = - low$. | |

Otherwise, forceful control is performed, using the following membership functions:

- | | | | | |
|-------------|-------------------|----------------------|-----------------------|------|
| R21: | If $\theta \gg 0$ | and $\omega \gg 0$, | then $F = + high$, | |
| R22: | If $\theta \gg 0$ | and $\omega = 0$, | then $F = + medium$, | |
| R23: | If $\theta \gg 0$ | and $\omega \ll 0$, | then $F = 0$, | |
| R24: | If $\theta = 0$ | and $\omega \gg 0$, | then $F = + medium$, | |
| R25: | If $\theta = 0$ | and $\omega = 0$, | then $F = 0$, | (32) |
| R26: | If $\theta = 0$ | and $\omega \ll 0$, | then $F = - medium$, | |
| R27: | If $\theta \ll 0$ | and $\omega \gg 0$, | then $F = 0$, | |
| R28: | If $\theta \ll 0$ | and $\omega = 0$, | then $F = - medium$, | |
| R29: | If $\theta \ll 0$ | and $\omega \ll 0$, | then $F = - high$. | |

3.3.3 Simulation Results for a Three-Level Actuator

Simulations have been conducted for the data as in section 3.2.3, except the following:

- the three levels of actuator force are chosen as high = 16 N, medium = 8 N and low = 4 N,

- the thresholds values for fine control are $\theta_{af} = -\theta_{df} = 0.2 \text{ rad}$ and $\omega_{af} = -\omega_{df} = 0.8 \text{ rad/s}$
- the sampling frequency is set to 100 Hz .

A sample of simulation results is shown in Figure 12: the pendulum angle and angular velocity (Fig. 12a) converge to a steady upright position within 1.5 seconds, with very small tracking errors after that time. The actuator force (Fig. 12b) displays very little activity once the control system enters the fine control mode. The benefit of this is that the overall actuator output (energy requirement) is around 3 times lower than in the case of single-level actuator with 100 Hz sampling, Figure 8.

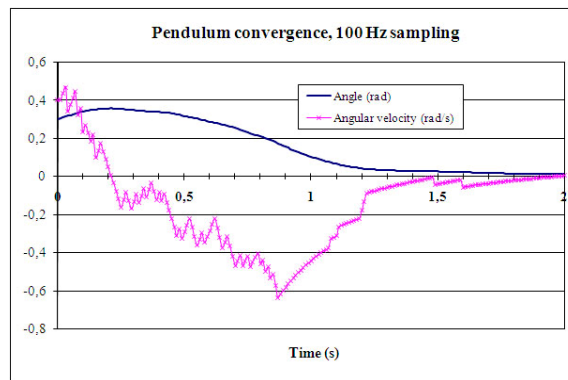

a) angle and angular velocity during the simulation

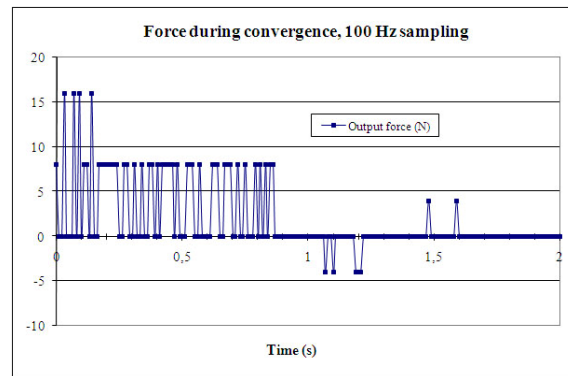

b) actuator force during the simulation

Figure 12

Aligning the inverse pendulum into the upright position, 100 Hz sampling, 16/8/4 N actuator

Conclusions

The paper shows the possibility to construct a stochastic fuzzy control system that utilizes low-resolution signals. The method for decomposing a fuzzy set into a time array of stochastic α -cut sets, which enables representation of the fuzzy membership function by a stochastic array of zeroes and ones, is practically implemented. This is a way of combining the probability theory with fuzzy logic, in a complementary manner.

For any fuzzy set, α -cut sets can be uncorrelated and then classical logic operations can be applied. Otherwise, it is possible to determine an α -cut set of all fuzzy sets for the same value of α and then utilize MIN and MAX logic operations. In this way, fuzzy rules of if-then type are transformed into logic expressions. As a result, control is reduced to determining the output values of these logic expressions. In MIN and MAX operations, one of the input variables is passed as an output. Hence features of one input are mirrored to the output; in this way the character of the random error in the input variable is unchanged. During the feedback measurement process, i.e. while gathering the input data for the controller, the chosen α value is introduced as a random error. The same error is reflected in every instantaneous control decision, but the error is sufficiently suppressed after an array of control decisions is made. In essence, the proposed control procedure follows a novel philosophy. Within every cycle the procedure is: dithering, coarse digitalization, making rough (inaccurate) control decisions, execution of those control actions. If this cycle is repeated in a very fast manner, the overall control errors will not exist.

The resulting control system is very simple and robust; it doesn't perform complex mathematical operations and can operate without a microprocessor; and it can very quickly make an array of control decisions. The effectiveness of a stochastic fuzzy control approach is validated by simulation.

Acknowledgement

This work was supported by the Serbian Ministry of Education and Science under Grant TR 32019.

References

- [1] G. J. Klir, B. Yuan: *Fuzzy Sets and Fuzzy Logic Theory and Applications*, Prentice Hall, 1995
- [2] T. Lazar, P. Pástor: Factors Limiting Controlling of an Inverted Pendulum *Acta Polytechnica Hungarica*, Vol. 8, No. 4, 2011, pp. 23-34
- [3] A. Pedrycz, F. Dong, K. Hirota. Finite Cut-based Approximation of Fuzzy Sets and its Evolutionary Optimization. *Fuzzy Sets and Systems*, Vol. 160, 2009, pp. 3550-3564

-
- [4] K. Nagy, M. Takács: Type-2 Fuzzy Sets and SSAD as a Possible Application, *Acta Polytechnica Hungarica*, Vol. 5, No. 1, 2008, pp. 111-120
- [5] V. Vujičić: Generalized Low Frequency Stochastic True rms Instrument, *IEEE Trans. Instrum. Meas.*, Vol. 50, 2001, pp. 1089-1092
- [6] V. Vujičić, S. Milovančev, M. Pešaljević, D. Pejić, I. Župunski: Low Frequency Stochastic True rms Instrument, *IEEE Trans. Instrum. Meas.*, Vol. 48, 1999, pp. 467-470
- [7] V. Vujičić, I. Župunski, Z. Mitrović, M. Sokola. Measurement in a Point Versus Measurement Over an Interval, *Proc. of the IMEKO XIX World Congress*, paper No. 480, 2009
- [8] B. Santrač, M. Sokola, Z. Mitrović, I. Župunski, V. Vujičić: A Novel Method for Stochastic Measurement of Harmonics at low Signal-to-Noise Ratio, *IEEE Trans. Instrum. Meas.*, Vol. 58, No. 10, 2009, pp. 3434-3441
- [9] J. Mao: Reduction of the Quantization Error in Fuzzy Logic Controllers by Dithering, Master's thesis, Ottawa-Carleton Institute for Electrical and Computer Engineering, University of Ottawa, November 1998
- [10] J. von Neumann: Probabilistic Logic and the Synthesis of Reliable Organisms from Unreliable Components, In *Automata studies*. CE Shannon, Ed. Princeton, NJ, Princeton University Press, 1956
- [11] L. A. Zadeh: Discussion: Probability Theory and Fuzzy Logic Are Complementary Rather Than Competitive, *Technometrics*, Vol. 37, No. 3, 1995
- [12] H. T. Nguyen: On Foundations of Fuzzy Theory for Soft Computing *International Journal of Fuzzy Systems*, Vol. 8, No. 1, 2006, pp. 39-45
- [13] W. C. Torrez, D. Bamber, I. R. Goodman, H. T. Nguyen: "A New Method for Representing Linguistic Quantifications by Random Sets With Applications to Tracking and Data Fusion" *Proceedings of the Fifth International Conference on Information Fusion (FUSION 2002)*, July 8-11, 2002, Annapolis, MD: Volume 1, pp. 1308-1315
- [14] R. Goodman: Random Sets and Fuzzy Sets: A Special Connection, *FUSION '98 International Conference*, pp. 93-100
- [15] S. Bodjanova: A Generalized α -cut. *Fuzzy Sets and Systems*, Vol. 126, 2002, pp. 157-176
- [16] Van-Nam Huynh, Y. Nakamori, J. Lawry: A Probability-based Approach to Comparison of Fuzzy Numbers and Applications to Target-Oriented Decision Making, *IEEE Trans. on Fuzzy Systems*, Vol. 16, No. 2, 2008, pp. 371-387

-
- [17] Y. Becerikliya, B. K. Celik: Fuzzy Control of Inverted Pendulum and Concept of Stability using Java Application, *Mathematical and Computer Modelling* 46, 2007, pp. 24-37
- [18] E. Minnaert, B. Hemmelman, D. Dolan: Inverted Pendulum Design with Hardware Fuzzy Logic Controller, *Systemics, Cybernetics and Informatics*, Vol. 6, No. 3, 2011 pp. 34-39
- [19] M. Akole, B. Tyagi: Design of Fuzzy Logic Controller For Nonlinear Model of Inverted Pendulum-Cart System, *XXXII National Systems Conference, NSC 2008*, pp. 750-755
- [20] M. I. El-Hawwary, A. L. Elshafei, H. M. Emara, H. A. Abdel Fattah: Adaptive Fuzzy Control of the Inverted Pendulum Problem, *IEEE Trans. on Control Systems Technology*, Vol. 14, No. 6, 2006, pp. 1135-1144
- [21] M. Dotoli, B. Maione, D. Naso, B. Turchiano: Fuzzy Sliding Mode Control for Inverted Pendulum Swing-up with Restricted Travel *Fuzzy Systems 2001, the 10th IEEE International Conference*, Vol. 3, pp. 753-756
- [22] C. H. Huang, W. J. Wang, C. H. Chiu: Design and Implementation of Fuzzy Control on a Two-Wheel Inverted Pendulum, *IEEE Trans. on Industrial Electronics*, Vol. 58, No. 7, 2011, pp. 2988-3001
- [23] C. W. Tao, J. S. Taur, T. W. Hsieh, C. L. Tsai: Design of a Fuzzy Controller with Fuzzy Swing-Up and Parallel Distributed Pole Assignment Schemes for an Inverted Pendulum and Cart System, *IEEE Trans. on Control Systems Technology*, Vol. 16, No. 6, 2008, pp. 1277-1288
- [24] J. Yi, N. Yubazaki: Stabilization Fuzzy Control of Inverted Pendulum systems, *Artificial Intelligence in Engineering* 14 (2000) pp. 153-163
- [25] N. Muškinja, B. Tovornik: Swinging Up and Stabilization of a Real Inverted Pendulum, *IEEE Trans. on Industrial Electronics*, Vol. 53, No. 2, 2006, pp. 631-639
- [26] B. Widrow and I. Kollár: Quantization Noise: Roundoff Error in Digital Computation, Signal Processing, Control and Communications, Cambridge University Press, 2008
- [27] A. Patel, B. Kosko: Noise Benefits in Quantizer-Array Correlation Detection and Watermark Decoding, *IEEE Trans. on Signal Processing*, Vol. 59, No. 2, 2011, pp. 488-505
- [28] R. Gayakwad: Optimized Fuzzy Logic for Motion Control, *Acta Polytechnica Hungarica*, Vol. 7, No. 5, 2010, pp. 161-168