

# Design of a Solar Tracker System for PV Power Plants

**Tiberiu Tudorache<sup>1</sup>, Liviu Kreindler<sup>1,2</sup>**

<sup>1</sup>Electrical Engineering Faculty, University Politehnica of Bucharest, 313 Splaiul Independentei, Sect. 6, Bucharest, Romania, e-mail: tudorach@amotion.pub.ro

<sup>2</sup> Technosoft, 266-268 Calea Rahovei, Sect. 5, Bucharest, Romania, e-mail: l\_kreindler@tehnosoftmotion.com

---

*Abstract: This paper deals with the design and execution of a solar tracker system dedicated to the PV conversion panels. The proposed single axis solar tracker ensures the optimization of the conversion of solar energy into electricity by properly orienting the PV panel in accordance with the real position of the sun. The operation of the experimental model of the device is based on a DC motor intelligently controlled by a dedicated drive unit that moves a mini PV panel according to the signals received from two simple but efficient light sensors. The performance and characteristics of the solar tracker are experimentally analyzed.*

*Keywords: Solar tracker system, design and execution, experimental investigations*

---

## 1 Introduction

The increasing demand for energy, the continuous reduction in existing sources of fossil fuels and the growing concern regarding environment pollution, have pushed mankind to explore new technologies for the production of electrical energy using clean, renewable sources, such as solar energy, wind energy, etc. Among the non-conventional, renewable energy sources, solar energy affords great potential for conversion into electric power, able to ensure an important part of the electrical energy needs of the planet.

The conversion of solar light into electrical energy represents one of the most promising and challenging energetic technologies, in continuous development, being clean, silent and reliable, with very low maintenance costs and minimal ecological impact. Solar energy is free, practically inexhaustible, and involves no polluting residues or greenhouse gases emissions.

The conversion principle of solar light into electricity, called Photo-Voltaic or PV conversion, is not very new, but the efficiency improvement of the PV conversion

equipment is still one of top priorities for many academic and/or industrial research groups all over the world.

Among the proposed solutions for improving the efficiency of PV conversion, we can mention solar tracking [1]-[3], the optimization of solar cell configuration and geometry [4]-[5], new materials and technologies [7]-[9], etc.

The global market for PV conversion equipment has shown an exponential increase over the last years, showing a good tendency for the years to come.

Physically, a PV panel consists of a flat surface on which numerous p-n junctions are placed, connected together through electrically conducting strips. The PV panel ensures the conversion of light radiation into electricity and it is characterized by a strong dependence of the output power on the incident light radiation.

As technology has evolved, the conversion efficiency of the PV panels has increased steadily, but still it does not exceed 13% for the common ones. The PV panels exhibits a strongly non-linear I-V (current - voltage) characteristic and a power output that is also non-linearly dependant on the surface insolation.

In the case of solar light conversion into electricity, due to the continuous change in the relative positions of the sun and the earth, the incident radiation on a fixed PV panel is continuously changing, reaching a maximum point when the direction of solar radiation is perpendicular to the panel surface. In this context, for maximal energy efficiency of a PV panel, it is necessary to have it equipped with a solar tracking system.

The topic proposed in this paper refers to the design of a single axis solar tracker system that automatically searches the optimum PV panel position with respect to the sun by means of a DC motor controlled by an intelligent drive unit that receives input signals from a light intensity sensor.

## **2 Solar Tracking and PV Panel Efficiency**

Compared to a fixed panel, a mobile PV panel driven by a solar tracker is kept under the best possible insolation for all positions of the Sun, as the light falls close to the geometric normal incidence angle. Automatic solar tracking systems (using light intensity sensing) may boost consistently the conversion efficiency of a PV panel, thus in this way deriving more energy from the sun.

Technical reports in the USA have shown solar tracking to be particularly effective in summer, when the increases in output energy may reach over 50%, while in autumn they may be higher than 20%, depending on the technology used.

Solar tracking systems are of several types and can be classified according to several criteria. A first classification can be made depending on the number of rotation axes. Thus we can distinguish solar tracking systems with a rotation axis, respectively with two rotation axes. Since solar tracking implies moving parts and control systems that tend to be expensive, single-axis tracking systems seem to be the best solution for small PV power plants. Single axis trackers will usually have a manual elevation (axis tilt) adjustment on the second axis which is adjusted at regular intervals throughout the year.

A single-axis solar tracking system uses a tilted PV panel mount, Fig. 1, and a single electric motor to move the panel on an approximate trajectory relative to the Sun's position.

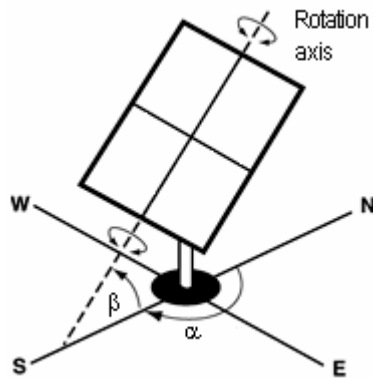

Figure 1

Principle of the single-axis solar tracking system

Another classification of solar tracking systems can be made depending on the orientation type. According to this criterion, we can identify solar tracking systems that orient the PV panels based on a previously computed sun trajectory, in comparison with panels with an on-line orientation system that reacts to the instantaneous solar light radiation. The later solution is more efficient and it was chosen for the solar tracking system proposed in this paper.

Another criterion for the solar tracker classification refers to its activity type. According to this criterion, we can distinguish active or passive solar trackers.

### 3 Design of the Proposed Solar Tracking System

The proposed solar tracking system should satisfy certain technical requirements specific to the studied application, as follows:

- minimum energy consumption, for the maximization of global efficiency of the installation and optimum performance-cost ratio;
- reliability in operation, under different perturbation conditions (wind, dust, rain, important temperature variations);
- simplicity of movement solution (motor, gears, sensors), to diminish the cost and to increase the viability;
- possibility of system integration in a monitoring and control centralized structure, which means a digital control solution.

Taking into account these implicitly necessary technical requirements, the chosen solution to drive the PV panel is based on the following components:

- a DC electric motor, voltage mode driven, with current monitoring, without movement sensors (speed or position);
- a motor control system of intelligent drive type, completely digital, that allows the implementation of the digital control of the motor as well as the implementation in a dedicated motion control language of the PV panel orientation application;
- a measurement system for light intensity applied to the PV panel, representing the sensor that commands the solar panel movement.

The chosen technical solution offers the following important advantages:

- simplicity of power scheme: DC motor and H bridge converter (4 transistors) for the motor drive;
- use of a compact drive equipment, with a high degree of integration and intelligence, that incorporates in a single module both the power converter and its command system, motion command unit (motion controller), and specific automation elements (of PLC type);
- use of an innovative solution, simple and reliable for the measurement system of light signal intensity.

#### 3.1 Motor Drive System

*DC motor.* The parameters of the DC motor used as the movement execution element are: rated voltage 24 V, rated current 3 A, maximum speed 3000 rpm, gear box with a speed reduction ratio of 1: 20.

*Intelligent drive unit IBL2403* [5]. To command the DC motor, we used the intelligent drive unit IBL2403, designed and executed by Technosoft® [10]. This component is a completely digital drive system, executed using DSP technology, dedicated to the command of DC electric motors, sinusoidal or trapezoidal commutated brushless motors or stepper motors. It accepts as position sensors, incremental encoders, digital or linear Hall sensors.

IBL2403 allows the command of the motor in voltage mode, current loop, speed or position loop. Being a control system in distributed architecture, it will be placed close to the electric motor, removing the distance problem, connecting wires and perturbations appearing for centralized control solutions.

The IBL2403 drive unit can be used in multi-axes structures; thus the proposed solution can be extended to an array of PV panels that can communicate with each other and with central computation unit by a CAN-bus communication line.

The IBL2403 unit is a drive unit programmable in the high level language TML (Technosoft Motion Language), which allows:

- the setting of various movement modes: profiles, PT, PVT, electronic cam, extern, etc.,
- on-line modification of movement mode,
- the execution of “homing” type movements,
- the execution of decisions in the program, jumps or TML function calls;
- handling of digital and analogical I/O ports of the drive unit;
- the execution of arithmetic and logical operations;
- communication among axes and the control of the movement of other axes;
- synchronization with other axes from a multi-axis system.

To access the drive unit, to set the drive parameters and to implement the motion application, one can use the EasyMotion Studio program, an integrated graphical platform that simplifies the application development.

The main characteristics of the IBL2403 ‘drive unit are the following:

- Completely digital drive, multi-motor (the same unit can control DC motors, sinusoidal or trapezoidal commutated brushless motors, and stepper motors);
- Voltage control, torque control, speed control of position control of the machine;
- Programmable motion modes: trapezoidal profile, S-curve, PT, PVT, electronic cam or gear box, external or analog reference, 33 Home modes;
- 5 programmable digital inputs;

- 2 programmable digital outputs;
- Communication protocols RS-232 and CAN;
- 1.5 kB RAM memory;
- 8 kB x 16 EEPROM memory;
- Rated frequency of PWM: 20 kHz;
- Supply voltage: 12-28 V, rated current 3 A, peak current 6 A,
- Compact design.

The layout of the IBL2403 drive unit and the connection of this drive to the DC motor and to the supply source are presented in Figs. 2-4.

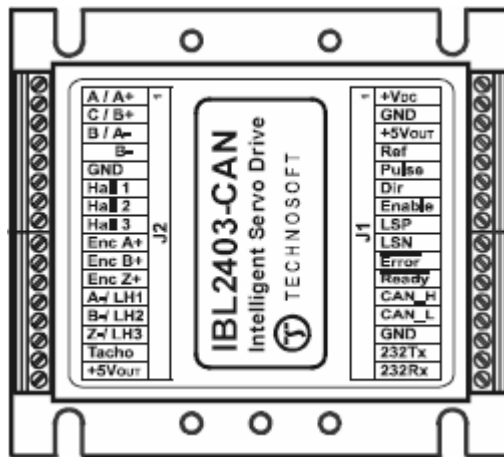

Figure 2

Layout of IBL2403 intelligent drive unit

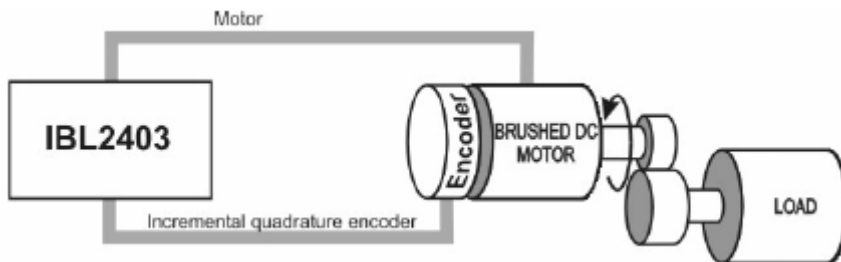

Figure 3

Dc motor drive scheme using IBL2403 unit

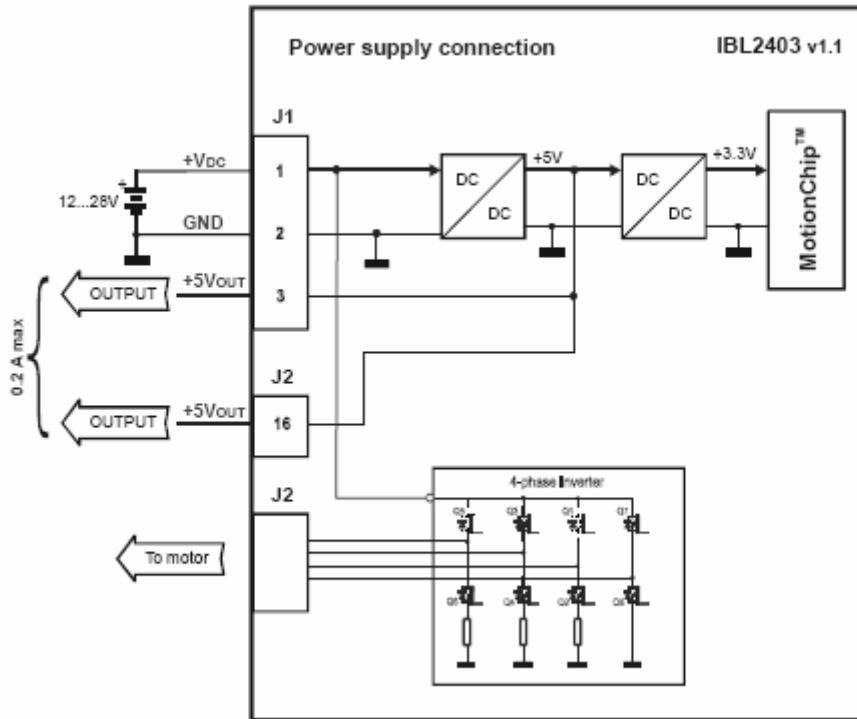

Figure 4

Connection of supply source and motor to the IBL2403 drive unit

### 3.2 Light Intensity Sensor

To command the PV panel motion, we used two light intensity sensors, executed using two luminescent diodes of LED type, placed so that the signal they generate is correlated with the light intensity applied to the PV panel, as in Fig. 5. The two LEDs are placed normal to the panel surface and are separated by an opaque plate. Thus, depending on the relative position between the PV panel and the solar light direction, one of the two LEDs will generate a stronger signal and the other LED a weaker one. In principle, the stronger signal will indicate the movement direction of the PV panel, so as to be normally oriented to the incident sun light rays and thus to have a maximum conversion efficiency of light into electricity. The operation scheme of the experimental model of the solar tracking system supposed the amplification of the two signals generated by the two LEDs up to the value range of the analog inputs of IBL2403 drive unit, at which were connected the two signals.

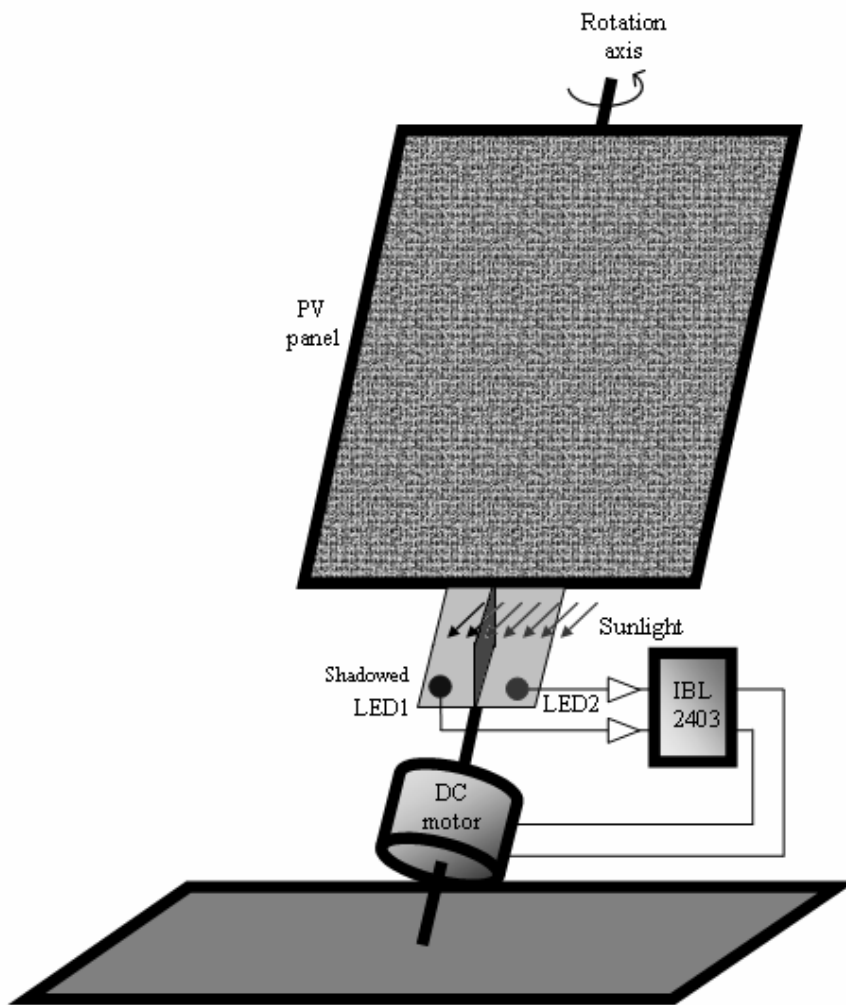

Figure 5

Principle of light sensors and motion control of PV panel

The proposed solution, which uses two independent light intensity sensors and the separate measurement of their output signals, has the following advantages:

- by measuring each separate signal we can detect, for the maximum signal intensity of the signal, if the light intensity is strong enough to justify the panel movement, which means additional energy consumption,
- in the case that the maximum signal intensity is higher than the minimum admitted values, an additional decision criterion of movement will be determined by the difference between the signals from the two LEDs. When



this difference becomes greater than an imposed limit, the command for a new movement of the PV panel will be triggered and thus the panel will be oriented again in order to achieve a better position with respect to the sun.

Thus, the proposed solution will remove the intermittent, frequent and unnecessary movements of the PV panel that would entail a higher consumption of energy, and thus decreasing in this way the conversion efficiency of the system.

We should point out that when the motor is not active, the power circuit of the IBL2403 drive unit can be completely deactivated, thus minimizing in this way the energy consumption of the system.

## **4 Experimental Model and Results**

Based on the design configuration presented in the previous section, we executed a completely operational small scale experimental model of a single-axis solar tracking system. With this model we were able to evaluate the specific control components using the Technosoft EasyMotion Studio platform. Starting from this small scale equipment, we can go forward and implement the proposed technology within larger power PV systems.

The experimental model, along with the light intensity measurement device and the two LEDs, are presented in Fig. 6.

The start-up of the designed system and the setting of the specific parameters of the motor and of the IBL2403 drive unit were executed using EasyMotion Studio.

In Fig. 7 is presented the dialog window for the DC motor parameter settings and in Fig. 8 the dialog window for the IBL2403 drive unit parameter settings.

In Figs. 9 and 10 are presented the variations of the received signals from the two LEDs, when a light source moves in front of the PV panel and the difference signal that can be used for the decision taking module to move the panel to the right or to the left.

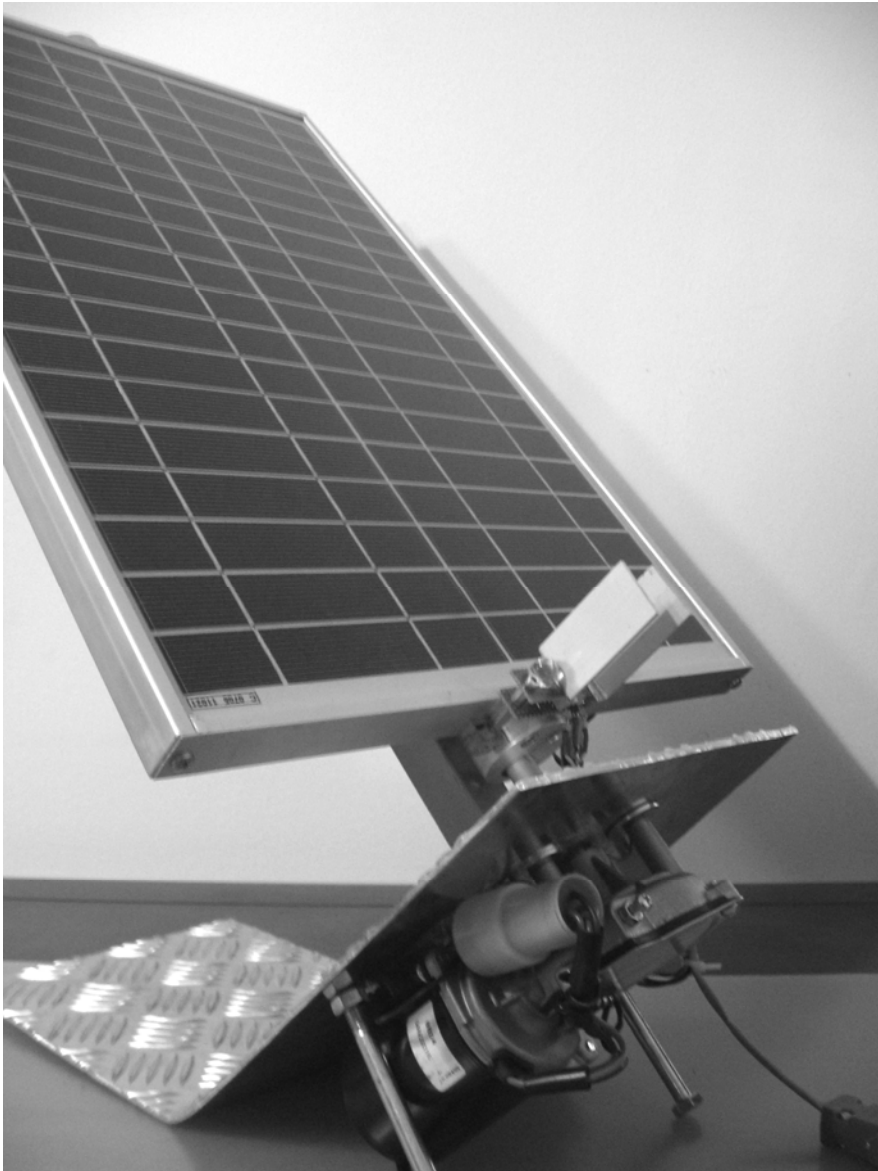

a)

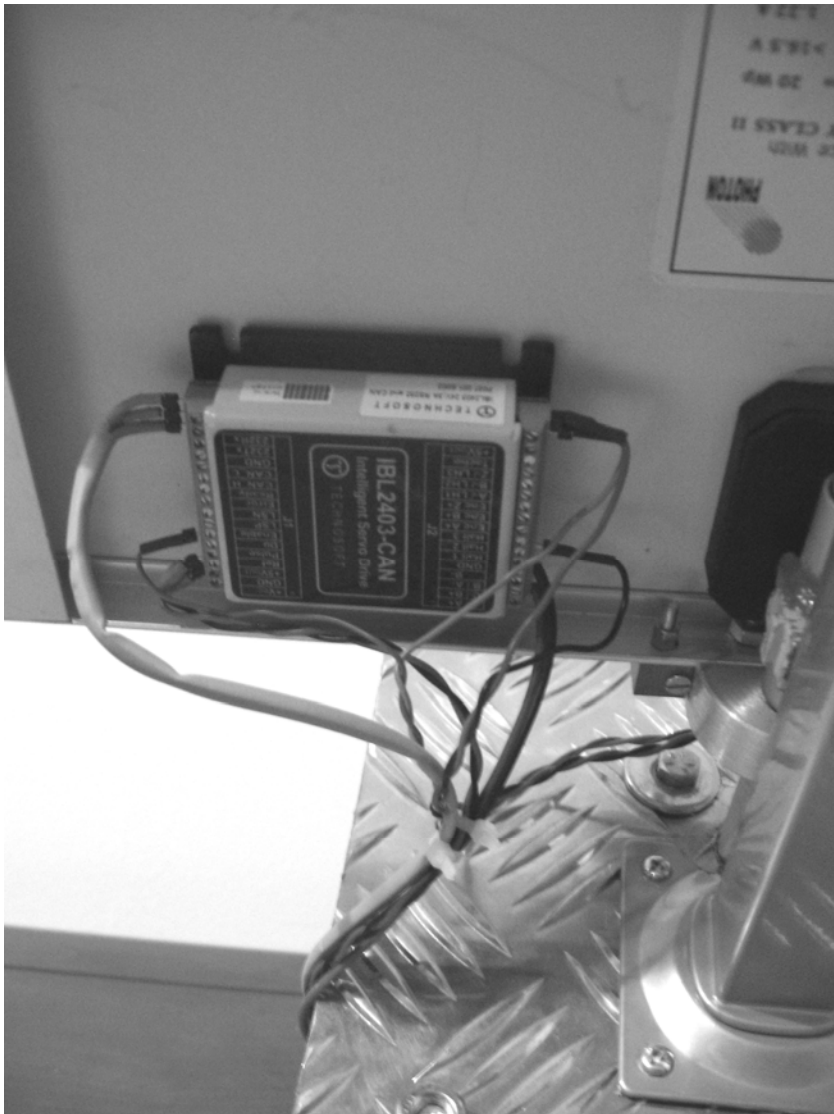

b)

Figure 6

Experimental model of a single-axis solar tracking system;  
a) system overview; b) detail of the IBL2403 drive unit

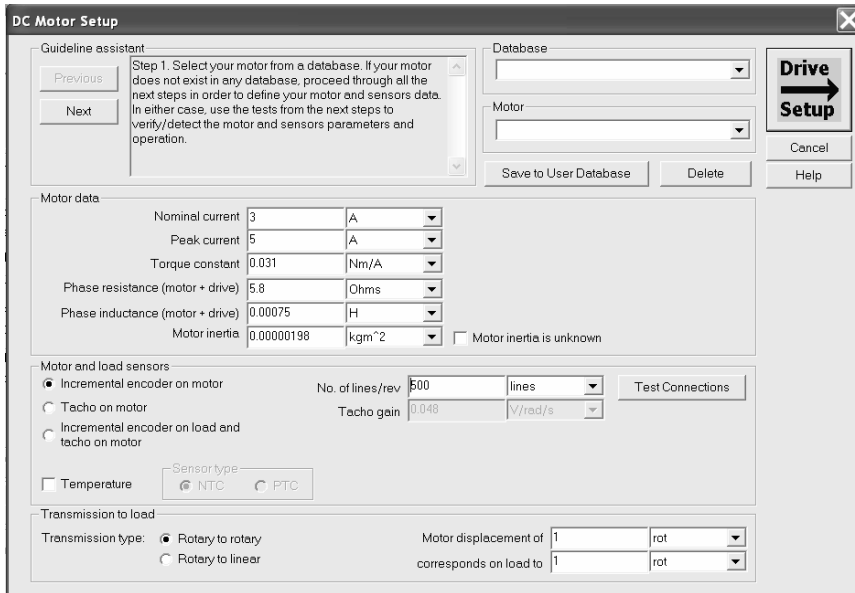

Figure 7  
Dialog window for DC motor parameter settings

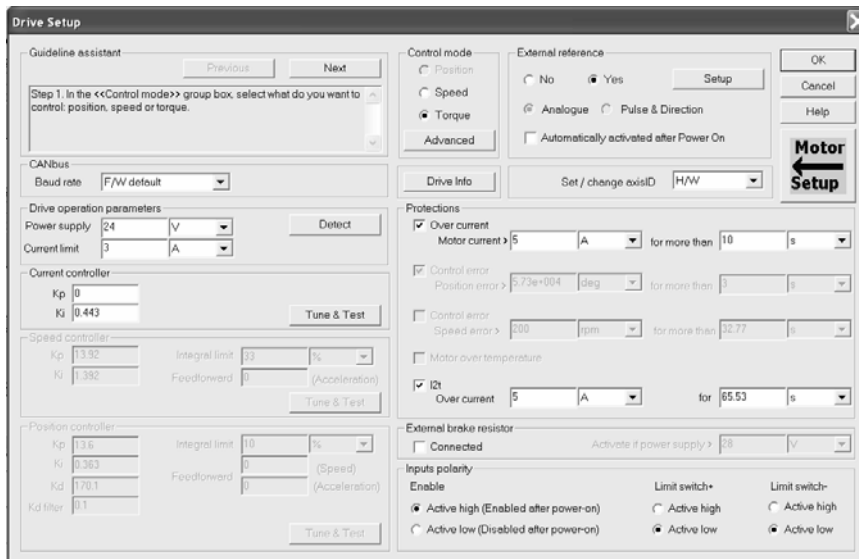

Figure 8  
Dialog window for IBL2403 drive unit parameter settings

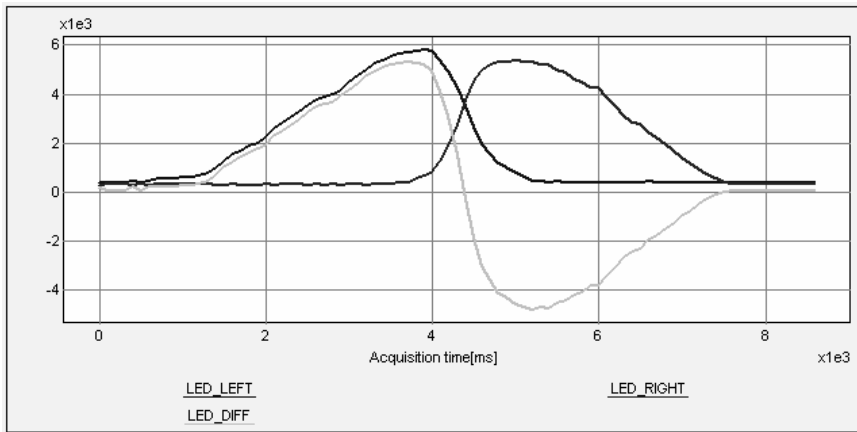

Figure 9

Signals received from the left and right LEDs and their difference when moving a light source from the left to the right, in front of the PV panel

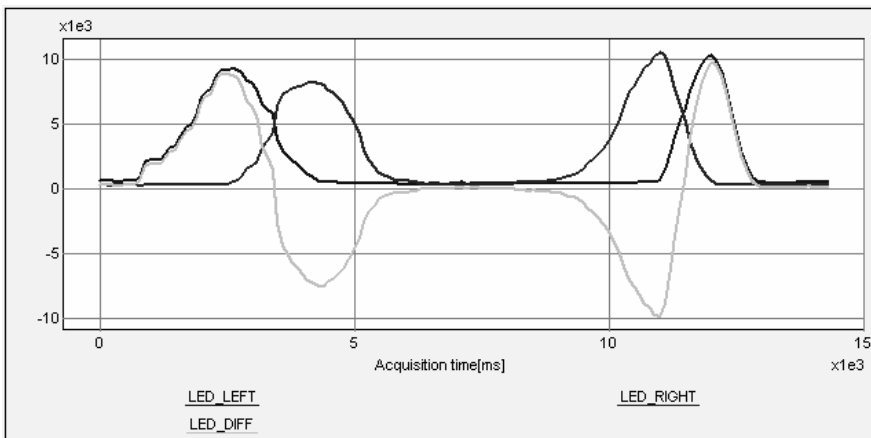

Figure 10

Signals received from the left and right LEDs and their difference when moving from the left to the right and back to the left, the light source, in front of the PV panel

Based on the difference between the two signals received from the two LEDs, compared with two imposed trigger values (programmable by the user), the command signals for the movement of the PV panel to the left or to the right were generated as in Figs. 11 and 12.

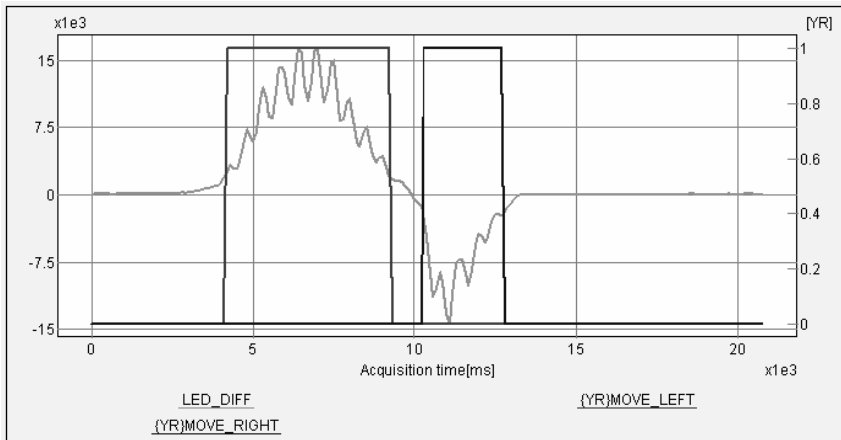

Figure 11

Generation of movement command of the PV panel to the right or to the left when moving a light source from the left to the right in front of the PV panel

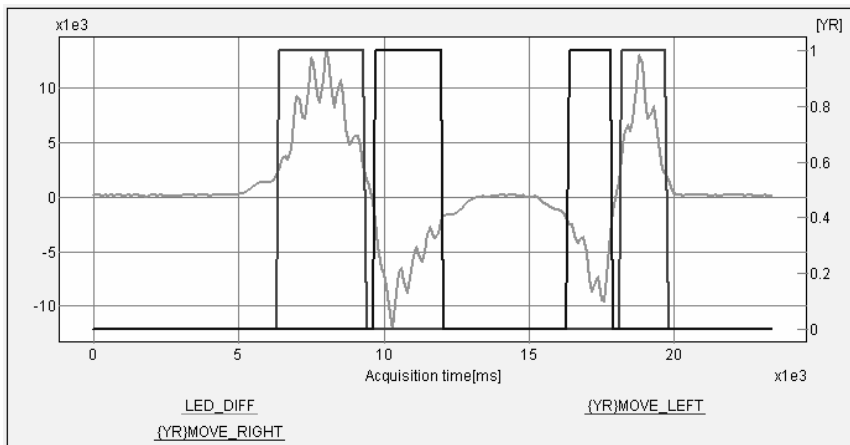

Figure 12

Generation of movement command of the PV panel to the right or to the left when moving a light source from the left to the right and back to the left, in front of the PV panel

In Fig. 13 are presented the variations of the signals received from the LEDs in stand-by state, when the difference between the two signals is lower than the trigger value for executing a movement command. We should notice that in the stand-by state no movement command is generated.

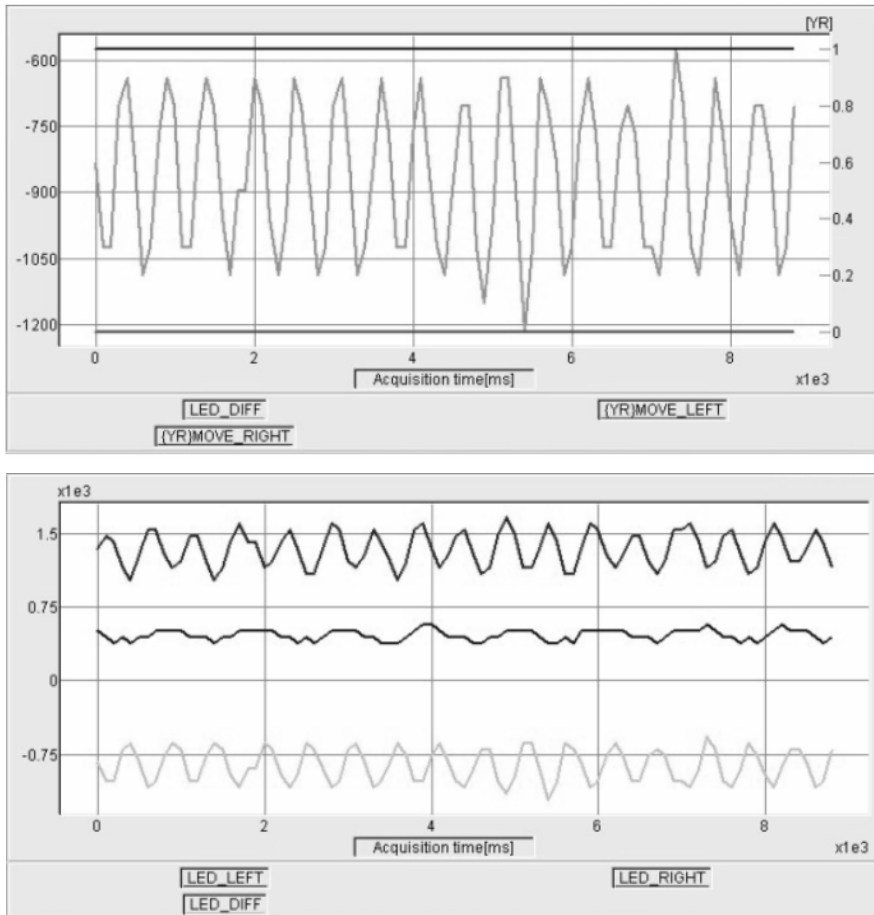

Figure 13  
LED signals in the stand-by zone

A global view of the EasyMotion Studio platform, used for the command application of the PV panel movement is shown in Fig. 14.

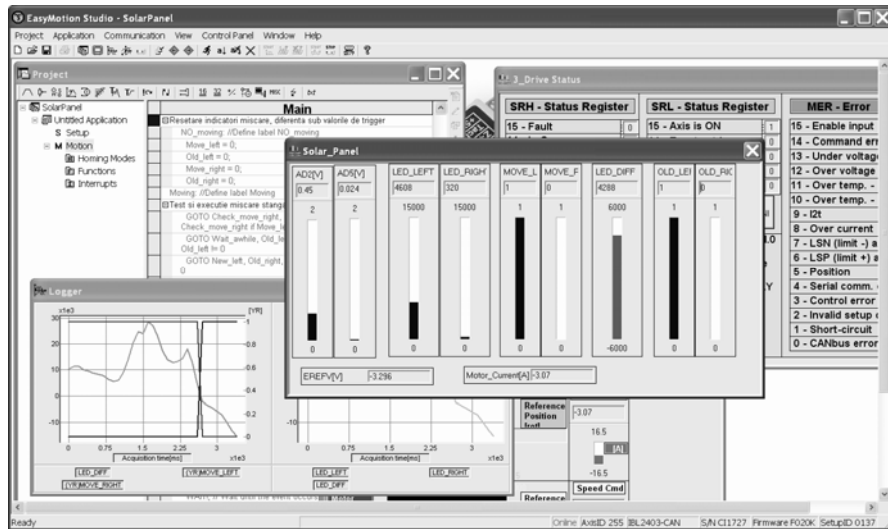

Figure 14

Global view of EasyMotion Studio platform developed by Technosoft

## Conclusions

Based on the obtained results we can conclude that the proposed solution for a solar tracking system offers several advantages concerning the movement command of the PV panel:

- an optimum cost/performance ratio, which is achieved via the simplicity of the adopted mechanical solution and the flexibility of the intelligent command strategy;
- a minimum of energy consumption, due to the fact that the panel movement is carried out only in justified cases, eliminating unnecessary consumption of energy, and due to the cutting of the power circuits supply between the movement periods of the PV panel;
- a maximization of output energy produced by the PV panel, through an optimal positioning executed only for sufficient values of light signal intensity;
- a guarantee of the panel positioning starting from any initial position of the PV panel;
- the elimination of unnecessary movements, at too small intensities of the light signals or at too small differences between the signals received from the two LEDs;



- the possibility of extending this solution to an array of PV panels, connected to each other, with inter-connected operability by CAN protocol communication among the panels and managed by a central computation unit for monitoring and control;
- the possibility of centralized monitoring and diagnosis of the system operation.

Based on the obtained results we can affirm that proposed solution is effective and presents interesting advantages from the point of view of practical applicability to larger power PV structures.

### **Acknowledgement**

This work was supported by the Romanian Ministry of Education and Research, in the frame of the research grant PNII, 21-075/2007.

### **References**

- [1] J. A. Beltran, J. L. S. Gonzalez Rubio, C.D. Garcia-Beltran: Design, Manufacturing and Performance Test of a Solar Tracker Made by an Embedded Control, CERMA 2007, Mexico
- [2] O. Stalter, B. Burger, S. Bacha, D. Roze: Integrated Solar Tracker Positioning Unit in Distributed Grid-Feeding Inverters for CPV Power Plants, ICIT 2009, Australia
- [3] M. A. Panait, T. Tudorache: A Simple Neural Network Solar Tracker for Optimizing Conversion Efficiency in Off-Grid Solar Generators, ICREPQ 2008, Spain
- [4] A. M. Morega, J. C. Ordonez, P. A. Negoias, R. Hovsapien: Spherical Photovoltaic Cells – A Constructal Approach to Their Optimization, OPTIM 2006, Romania
- [5] A. M. Morega, A. Bejan: A Constructal Approach to the Optimal Design of Photovoltaic Cells, Int. Journal of Green Energy, pp. 233-242, 2005
- [6] J. Horzel, K. De Clerq: Advantages of a New Metallization Structure for the Front Side of Solar Cells, 13<sup>th</sup> EC Photovoltaic Solar Energy Conference, France, 1995
- [7] P. I. Widenborg, G. Aberle: Polycrystalline Silicon Thin-Film Solar Cells on AIT-Textured Glass Superstrates, Advances in OptoElectronics Journal, Vol. 2007
- [8] P. A. Basore: Manufacturing a New Polycrystalline Silicon PV Technology, Conference Record of the 2006 IEEE 4<sup>th</sup> World Conference on Photovoltaic Energy Conversion, pp. 2089-2093, 2006
- [9] P. Turmezei: Chalcogenide Materials for Solar Energy Conversion, Acta Polytechnica Hungarica, Vol. 1, No. 2, pp. 13-16, 2004
- [10] Technosoft: IBL2403 Intelligent Drive User Manual