

USING PARTICULATE DRAWINGS TO STUDY 13-17 YEAR OLDS' UNDERSTANDING OF PHYSICAL AND CHEMICAL COMPOSITION OF MATTER AS WELL AS THE STATE OF MATTER

© Zoltán Tóth and Edina Kiss
tothzoltandr@yahoo.com

Using Sanger's particulate drawings [J. Chem. Educ. 2000, 77, 762-766.] a study was made of the understanding of the physical and chemical composition, and of the state, of matter, among Hungarian students aged 13-17. The evaluation of data at three levels (statistical analysis, content analysis of responses and structural analysis using knowledge-space theory) provided clearer and more reliable information about the conceptualization and cognitive organization of students' knowledge. The results show that Hungarian students have serious problems in distinguishing between homogeneous and heterogeneous mixtures, as well as the physical and chemical composition of matter. Among the classification strategies of unsuccessful students, both visual methods, including formal inspection of drawings, and conceptual methods, could be identified. According to the structural analysis (knowledge-space theory) only slight and temporary changes in the students' cognitive structure could be observed. A slight development in understanding of these basic concepts could be observed in grades 8 and 10 when Hungarian students study inorganic and organic chemistry.

Particulate drawings are very important tools for describing the nature of matter at the sub-microscopic level. Furthermore, these pictures are quite useful in determining and improving students' conceptions of different basic chemical ideas.

Nurrenbern and Pickering (1987) used particulate pictures to create conceptual questions in a study carried out among freshmen to compare conceptual questions and traditional (algorithmic) questions. Their research argued that 'teaching students to solve problems about chemistry is not equivalent to teaching them about the nature of matter. Students can solve problems about gases without knowing anything much about the nature of a gas, and they can solve limiting-reagent problems without understanding the nature of chemical change'. Particulate pictures as conceptual questions were used in other research studies to distinguish between conceptual thinkers and algorithmic problem-solvers among students in tertiary education (Nakhleh, 1993; Zoller et al. 1995). Gabel et al. (1987) investigated the views of prospective elementary teachers of the particulate nature of matter. The test showed pictures of matter with atoms and molecules symbolized by circles and shading. They found that, even after the study of chemistry, students could not distinguish between some of the

fundamental concepts such as solids, liquids, and gases, or elements, mixtures, and compounds in terms of particle model. On the basis of multiple-choice question used by *Nurrenbern and Pickering (1987)*, *Sanger (2005)* has developed stoichiometric questions for evaluating students' conceptual understanding of balanced equations and stoichiometric ratios by means of particulate drawings.

Johnson (1998) also used particulate drawings in a longitudinal study among 11-14 year olds. During interviews, students had to draw particulate pictures. As a result of this study Johnson found four particle models and explored changes in pupils' alternative ideas. Drawing particulate pictures proved to be useful in studying students' misconceptions concerning the sub-microscopic interpretation of chemical reactions (*Laverty and McGarvey, 1991*).

Briggs and Holding (1986) explored how 15-year-old students apply particle ideas in making the distinctions between elements, compounds and mixtures. They used coloured dots to represent different atoms in diagrams of a mixture of two elements, a compound and an element alone. Later, other researchers also used these diagrams to study the conceptual understanding of elements and compounds among secondary-school students (*Laverty and McGarvey, 1991; Barker, 1995*).

In 2000, *Sanger (2000)* used five particulate drawings (Figure 1) to determine and improve students' conceptions of solids, liquids, gases, pure substances, heterogeneous and homogeneous mixtures as well as elements and compounds. In his paper Sanger described interviews with students, whose purpose was to identify the ways in which students classify particulate drawings. The successful classification strategies were incorporated into an instructional lesson. The effectiveness of this lesson was discussed in detail.

Figure 1. Particulate drawings used in this study - reprinted from Sanger's paper (Sanger, 2000).

The following drawings contain representations of atoms and molecules. Classify each of these drawings (labeled 1–5) according to the three characteristics listed below. You should classify all five drawings for each category.

1 2 3

4 5

State of matter

_____ solid liquid gas

Physical composition of matter

_____ pure substance heterogeneous mixture homogeneous mixture

Chemical composition of matter

_____ elements compounds both

Finally, it is noted that *Taber* (2002) in his book '*Chemical Misconceptions – Prevention, Diagnosis and Cure*' also uses a lot of particulate diagrams for exploring students' misconceptions in different topics of chemistry.

Research Questions, Sample and Methodology

In this study we have tried to answer the following questions.

1. How successful are 13-17 year old Hungarian students in identifying solids, liquids, gases, elements, compounds, pure substances, and homogeneous and heterogeneous mixtures at the particulate level?
2. What types of classification methods and misconceptions occur in identifying particulate drawings?
3. Is there any difference in the classification methods, or in the 'knowledge structures', between the students of different ages?
4. Can we demonstrate any development in understanding these basic concepts during their education?

In our study we used particulate drawings (Figure 1) developed by Sanger (2000) in a written test. Students were asked to classify each drawing according to its state of matter, and its physical and chemical composition. (The first picture represents a solid, heterogeneous mixture of element and compound. The second is a gas, and a homogeneous mixture of an element and a compound. The third diagram depicts solid matter, as a pure substance and an element. The fourth is a liquid, and a homogeneous

mixture of two elements. We can identify the fifth picture as a gas, a pure substance, and a compound.)

The data were collected at the end of the school year 2002/2003. A random sample of 702 out of 2954 Hungarian secondary school students (grades 7 to 11, age 13 to 17) from 17 schools participated in the test. (7th graders: 163; 8th graders: 161; 9th graders: 135; 10th graders 127; and 11th graders: 116.) The 7th graders have one or two lessons of chemistry per week, and 8th to 10th graders have two lessons per week. Just a few students have chemistry lessons at 11th grade. It is noted that Hungarian chemistry textbooks mainly use spherical models, and space filling or ball-and-stick models for representation of atoms, and molecules, respectively.

The reliability coefficients (Cronbach- α) of the test varied between 0.8125 and 0.8785 depending on the grade. This means that Sanger's pictures can be used as an instrument for testing our 7-11th graders.

Data obtained from this survey were analysed at three levels. For the statistical analysis we used the SPSS software. To identify students' strategies their responses were examined by content analysis. To look for the connectivity in students' responses (their cognitive organization of the concepts) a structural analysis was done by applying knowledge-space theory (KST).

The *knowledge-space theory* (KST) was developed by *Falmagne et al.* (1999), and its application to science concepts has been previously demonstrated by *Taagepera et al.* (1997; 2000; 2002) and *Arasasingham et al.* (2004; 2005). For this analysis, tests were scored in a binary fashion, as being either right (1) or wrong (0). The set of items answered correctly by a student is called a response state. As we used five-item tests theoretically we can have 32 (2^5) possible response states, from the null state [0] where no items were answered correctly to the final state [1,2,3,4,5] where all the pictures were identified correctly. A set of response states for a student group gives the 'response structure'. Starting from this response structure one can recognize a subset of response states (or 'knowledge structure') fitted to the original response structure at the $p = 0.05$ level of significance. There are several ways of finding the 'knowledge structure' from the 'response structure'. These methods have two common features: (i) lucky-guess and careless-error parameters (most often 0.1) for each item estimated; (ii) the 'knowledge structure' has to be well graded (*e. g.* each knowledge state must have a predecessor state and a successor state except for the null state and the final state with correct answers to all questions).

Taagepera et al. determined the 'knowledge structure' by a systematic trial-and-error process using χ^2 analysis (2000; 2002). They started with the most populated response states, then added or subtracted response states to minimize the χ^2 value while forming an interconnected network with 30-40 knowledge states. Among the pathways from the null state to the final state (so-called 'learning pathways') the most probable learning pathway was identified as the critical learning pathway characteristic of the sample. The researchers used a Visual Basic computer program for the calculation (*Potter*).

We used a slightly different method for determining the knowledge structure and the critical learning pathway. First, by means of *Potter's* computer program we converted the response structure into a so-called empirical knowledge structure having all the possible response states for different predicted populations. This empirical knowledge structure was the starting point in the trial-and-error process to find the final knowledge

structure. For the selection of the critical learning pathway among the possible pathways we applied both the χ^2 method (method 'chi'), and the higher probabilities method (method 'prob') used by *Taagepera et al.*

We also used the Hexagon Data Analysis (hDA) from the Iloydesign software developed recently by the UCI (University of California at Irvine) research group (*Lloyd*). hDA is a powerful analysis software program for the creation and study of statistically significant, abbreviated representation structures of hierarchically-organized input data. Similar to our process in this method the original input data (response states) are converted into the empirical knowledge structure having all the possible response states for different predicted populations. Starting from this empirical knowledge structure, hDA gives the proposed knowledge structure and the top four pathways, in a few minutes (method 'hDA').

In the case of the 15 knowledge structures that we examined, all the above three methods (methods 'chi', 'prob', and 'hDA') were tried. We obtained the same result for the critical learning pathway in respect of 13 knowledge structures. In one case (identifying the chemical composition of matter in grade 10) the method 'chi', in another case (classification of the state of matter in grade 7) the method 'hDA' gave a different learning pathway from the other two methods.

Results and Discussion

As seen in Figure 2 the overall test score increases with the grade except for grade 11. (The regression observed in the case of the 11th graders can be explained by the lack of chemistry lessons.) However, analysis of variance (one-way ANOVA) shows that only the performance of 7th graders differs significantly ($p < 0.005$) from that of 8-11th graders, and there is also a significant difference ($p = 0.011$) between the scores of 8th and 10th graders. This indicates that there is considerable development in identifying particulate drawings in grades 8 and 10.

In the following we present and discuss the students' responses according to the three classification categories (state of matter, physical composition of matter, and chemical composition of matter) in detail.

**Figure 2. The overall test score for students of different grades.
(The maximum value for the score is 15.)**

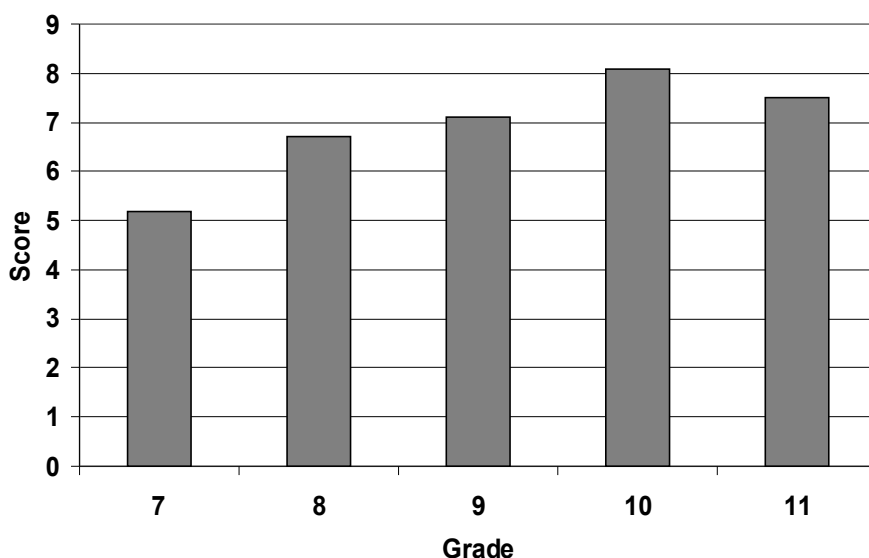

State of Matter

Figure 3 summarizes the results of identification of particulate drawings according to the state of matter (solid, liquid or gas). It is seen that the average percentage of correct answers increases with the grade. However there is no significant difference between grades 8, 9, and 11, nor is there between grades 9, 10, and 11 ($p = 0.081-0.992$). Similar to the overall test scores the success in explaining the state of matter at particulate level increases significantly in 8th and 10th grades. It is noted that these results (48.4-74.4%) do not reach to the level of *Sanger's* college students (average percentage of correct answers in the control group: 87.8%) (*Sanger, 2000*).

Figure 3 also shows that for our students the classification of picture 1 (as solid sample) was the easiest (percentage of correct answers: 71.2%), whilst the identification of the liquid sample (picture 4) gave the lowest result (percentage of correct answers: 58.3%). A similar order was found by *Sanger (10)*. These results are contrary to the findings of *Stavy and Stachel (1985)* who established that in general children classified liquids more easily than solids.

Figure 3. Results for students in identifying picture 1-5 according to the state of matter.

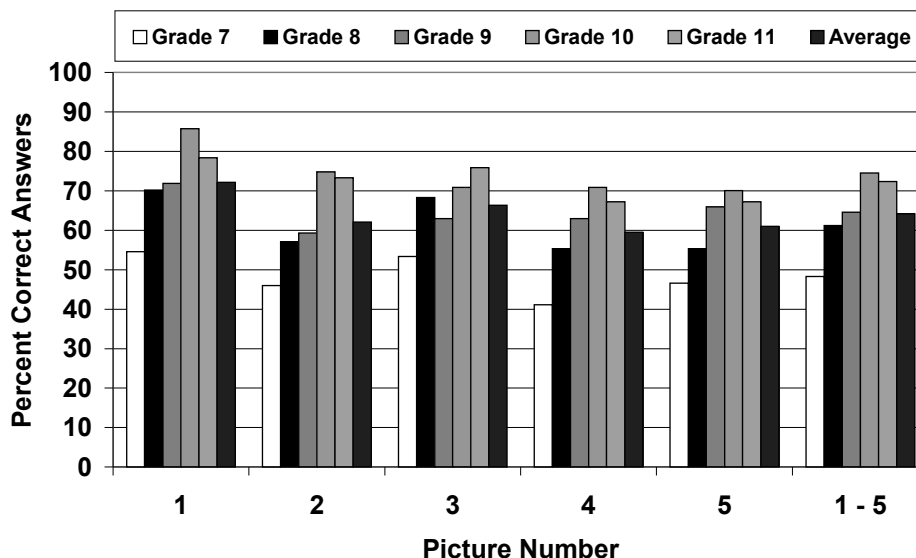

Figure 4 contains the critical learning pathways obtained by KST analysis. It is seen that, except for 9th graders, our students could integrate the concept of solid matter (pictures 1 and 3) into their cognitive structure much better than the concepts of a liquid and a gas. In all the five critical learning pathways the classification of picture 4 as liquid is toward the end of the hierarchy. The last position for identifying picture 5 as gas in these hierarchies can be explained by the fact that many students may think that the symbol ‘O▲O’ represents the water molecule, and it is known from other studies (*Stavy and Stachel, 1985*) that water is generally believed to be a liquid.

There is a considerable change in the critical learning pathways only in grade 9. In contrast to the other students, for 9th graders, identifying picture 5 as gas is the most internalized item of knowledge. Maybe it is the consequence of the fact that students in grade 9 study the changes in the state of matter in detail. So they know that water can also exist in a gaseous state. However, this change in the students’ cognitive structure is not long lasting: a rearrangement can be observed in grade 10; and the critical learning pathway for 11th graders is exactly the same as that in grades 7 and 8.

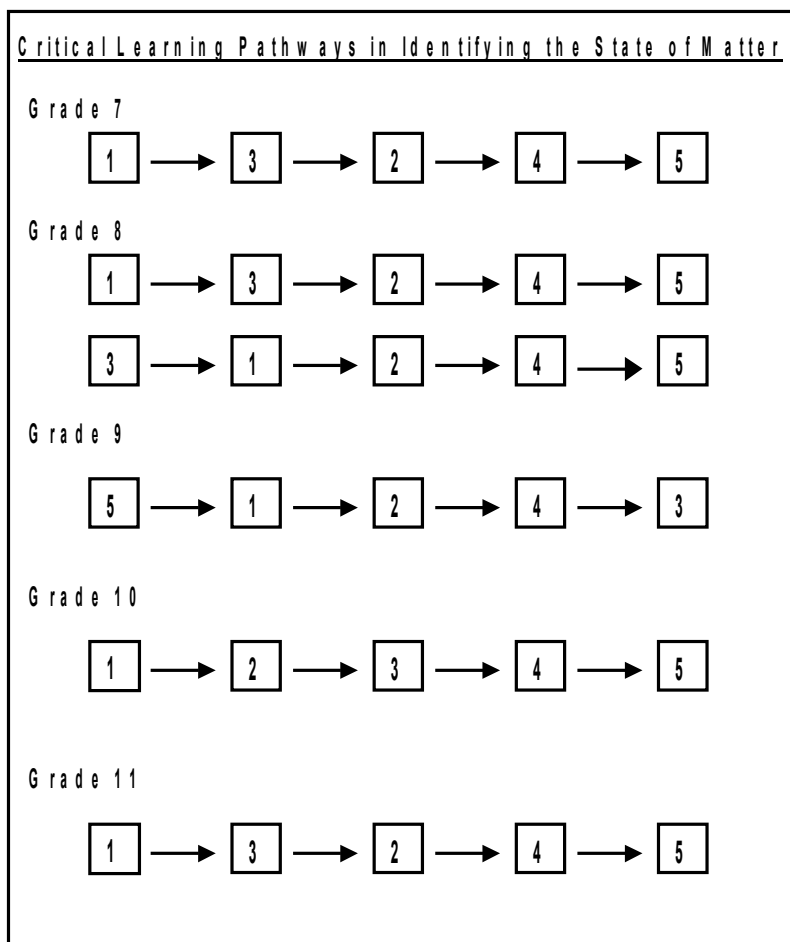

Figure 4. Critical learning pathways in identifying the state of matter.

During the content analysis of the written responses we tried to identify the most frequently used classification methods. In identifying particulate drawings according to the state of matter we collected typical student responses. Table 1 shows four typical incorrect answers and the corresponding correct answers. The source of the incorrect answers could be the classification methods (strategies A1-A4) used by unsuccessful students. However, in spite of the fact that the frequency of these classification methods is very low (less than 7% of the total number of students, but around 10% of the number of students giving complete answers), analysis of their content and the change according to their grades may be interesting.

Among the four classification schemes under review, we could only explain methods A1-A3. Students working with method A1 gave picture 5 as a liquid, because they believed that picture 5 represented water molecules. In method A2 students made a mistake in identifying picture 3. They classified this picture as a liquid sample. This mistake suggests a misconception that the particles in solid samples should be organized in the same repeating pattern in the three dimensions of space or the two dimensions of the plane, as shown in picture 1. Students using method A3 probably believed that particles in gases should be the same, therefore they identified picture 2 as a liquid sample. Unfortunately we could not identify classification method A4 on the basis of students' written responses.

Table 1. Classification Methods Identified from Students' Written Responses (The State of Matter)

Method	Students' Response Solid / Liquid / Gas	Percentage of Responses in Grades*				
		7 n= 163	8 n=161	9 n=135	10 n=127	11 n=116
A1	1,3 / 4,5 / 2	3.7%	3.7%	5.9%	3.9%	2.6%
A2	1 / 3,4 / 2,5	1.8%	1.9%	6.7%	4.7%	3.4%
A3	1,3 / 2,4 / 5	1.2%	5.0%	5.2%	2.4%	3.4%
A4	1,3 / 2,5 / 4	3.1%	4.3%	3.0%	3.9%	1.7%
Correct	1,3 / 4 / 2,5	25.8%	36.0%	34.1%	48.8%	50.9%
	Other complete	14.7%	9.4%	10.3%	10.3%	7.8%
	None	27.6%	15.5%	14.1%	3.9%	9.5%
	Incomplete	22.1%	24.2%	20.7%	22.1%	20.7%

*The percentage of the most frequently used methods is highlighted in bold.

Data in Table 1 also show the change in the most frequently used classification methods with the grade. Method A1 is the first one in grade 7, but it changes into method A3 in grade 8, and from grade 9 the method A2 is the most popular identification method for unsuccessful students. This indicates that together with the three main classification methods three basic misconceptions are changing between grades 9-11. The first misconception ('water is always a liquid') changes in grade 8 into another one ('particles of gases should be the same'), and in grades 9-11 a third misconception ('particles in solid samples should be organized in the same repeating pattern') is the leading one.

Physical Composition of Matter

In identifying the state of matter the most important factor in the decision is the arrangement of particles, whether they are atoms or molecules – in other words, the connection between particles or the distance between symbols. It is not an easy problem for students, especially for our students who are not familiar with using such a type of particulate diagrams. As noted earlier, Hungarian chemistry textbooks mainly use spherical models, and space filling or ball-and-stick models, for the representation of atoms, and molecules, respectively, and always show the connection (bonding) between the atoms in molecules.

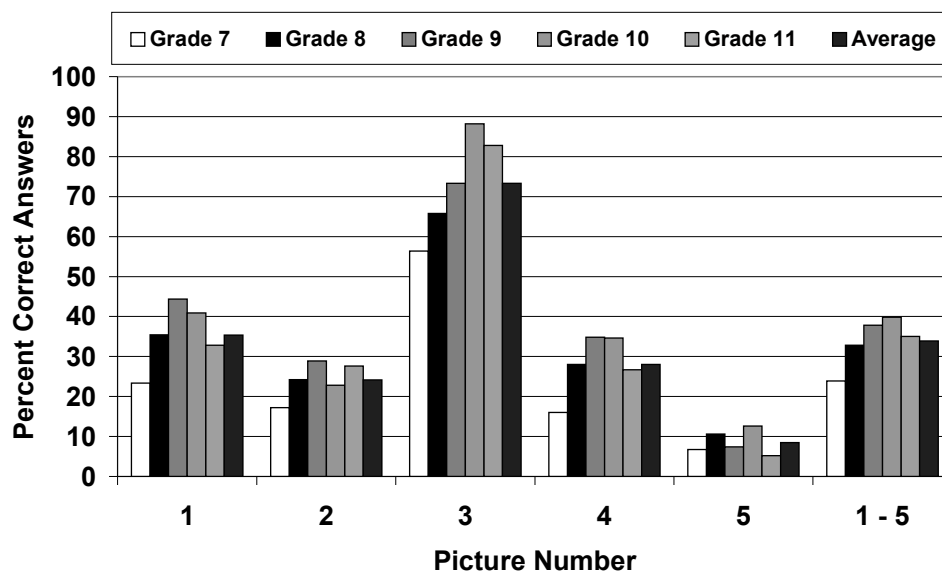

Figure 5

Figure 5 shows the results of identification of particulate drawings according to the physical composition of matter (pure substance, heterogeneous mixture or homogeneous mixture). Although the average percentage of correct responses increases with the grade, there is no significant difference between the scores of 8-11th graders by the one-way ANOVA ($p = 0.161-0.964$). We found statistically significant differences only between the results of 7th graders and 8-11th graders ($p < 0.018$). The success of our students (33.4%) is also lower than that of Sanger's students who are college students (46.4% for the control group) (Sanger, 2000).

Figure 5 also shows that, as in Sanger's findings, the identification of picture 3 (as pure substance) was the easiest task for our students. In contrast to Sanger's students, for Hungarian secondary school students the classification of picture 5 as pure substance caused the greatest problem (success rate is 8.5%).

Figure 6 summarizes the results of KST analysis. The critical learning pathways obtained for the different grades show that there is no remarkable change in the students' cognitive structure, in the hierarchy of concepts, regarding physical states of matter. Only the critical learning pathway of 7th graders differs slightly from the others. At the two ends of critical learning pathways there are pure substances (picture 3 and 5) indicating that in general pure substance is integrated into the students' cognitive structure as matter containing the same atoms.

Figure 5. Results for students in identifying picture 1-5 according to the physical composition of matter.

We can gain further insight into the explanation for this hierarchy of concepts by considering the typical identifying methods of unsuccessful students. In his paper Sanger (2000) discusses this problem in detail. Based on the students' interviews he found two classification methods (X1 and X2) and suggested three identifying strategies ('visual', 'sampling' and 'randomly mixed'). The majority of his students distinguished between heterogeneous and homogeneous mixtures using macroscopic characteristics. Students using a 'visual' strategy classified pure compounds as homogeneous mixtures (picture 5), and identified all mixtures as heterogeneous mixtures (pictures 1, 2 and 4). This method was given the symbol X1 by Sanger, and is assigned as method B3 in our study (Table 2). Students using the other method (X2, method B4 in this study) identified four pictures correctly, but classified pure compounds as homogeneous mixtures (picture 5). The 'sampling' strategy may be

effective in identifying macroscopic samples of matter, but can be very misleading when taking different samples from a picture containing some particles.

Sanger (2000) neatly demonstrated that his students start out using X1, then from the effect of instructional lessons they move on to X2, and finally they reach the correct answer.

Figure 6. Critical learning pathways in identifying the physical composition of matter.

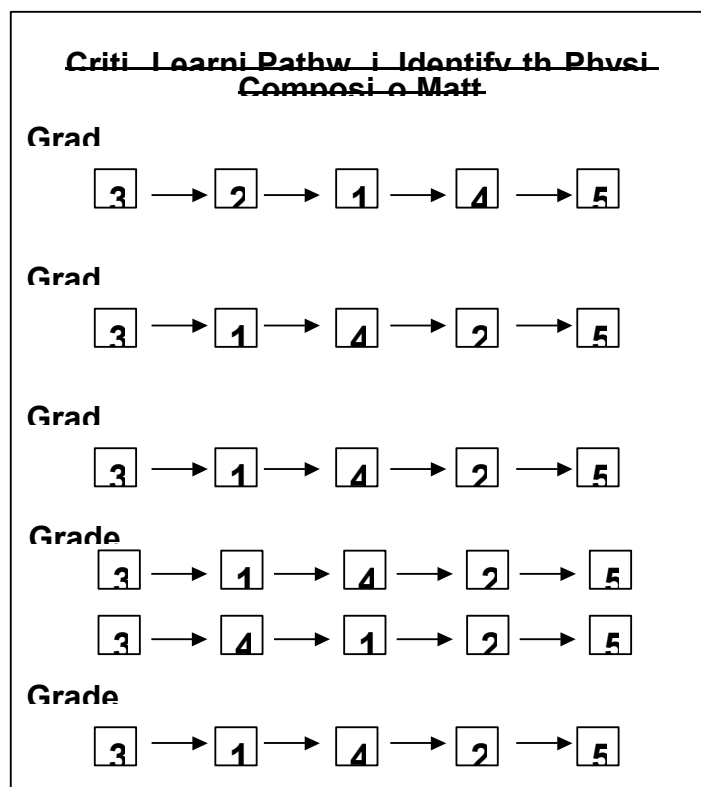

Our data show much greater variety in unsuccessful classification methods than observed by Sanger. Table 2 summarizes a selection of the methods that we identified.

Method B1 is a visual strategy. If there is any visual difference in the particles shown in the picture this should be a sample of a heterogeneous mixture. Students using this strategy divide the matter into two groups: pure substances (picture 3), and heterogeneous mixtures (pictures 1, 2, 4 and 5).

Method B2 is a mixture of the 'visual' and 'sampling' strategies. In the case of heterogeneous mixtures one can see different 'phases' separated by visual 'surface' in the picture (pictures 1 and 4), otherwise the picture showing different signs represents a homogeneous mixture (pictures 2 and 5).

Table 2. Classification Methods Identified from Students' Written Responses (The Physical Composition of Matter)

Method	Students' Response Pure substance / Heterogeneous mixture / Homogeneous mixture	Percentage of Responses in Grades*				
		7 n=163	8 n=161	9 n=135	10 n=127	11 n=116
B1	3 / 1,2,4,5 / -	1.2%	0.6%	1.5%	2.4%	0.0%
B2	3 / 1,4 / 2,5	4.9%	2.5%	3.7%	2.4%	4.3%
B3	3 / 1,2,4 / 5	0.0%	5.6%	5.9%	3.9%	6.0%
(X1**)	3 / 1 / 2,4,5	0.6%	5.0%	10.4%	2.4%	3.4%
B4	3 / 1,2 / 4,5	3.7%	6.8%	6.7%	15.7%	7.8%
(X2**)	3 / 2,4 / 1,5	1.2%	3.1%	3.7%	6.3%	10.3%
B5	3,5 / 1 / 2,4	0.6%	1.9%	2.2%	1.6%	0.9%
B6	Other complete	14.2%	20.5%	20.7%	26.7%	26.8%
Correct	None	33.7%	18.0%	19.3%	6.3%	9.5%
	Incomplete	39.9%	36.0%	25.9%	32.3%	31.0%

*The percentage of the most frequently used methods is highlighted in bold.

**Methods identified first by *Sanger* (2000).

Methods B3 and B4 are the equivalent of *Sanger's* X1 and X2, respectively. They were described earlier.

Students using method B5 classify particulate drawings according to the diversity of symbols in the picture. One kind of symbols indicates a pure substance (picture 3), two kinds of symbols depict a homogeneous mixture (pictures 4 and 5), whilst three kinds of symbols represent a heterogeneous mixture (picture 1 and 2).

In method B6 the arrangement of the symbols in the picture is the key factor in the classification. In the case of homogeneous mixtures, particles of different types are well arranged (pictures 1 and 5) contrary to the heterogeneous mixtures where the arrangement of the particles is chaotic (pictures 2 and 4).

It is also seen from the data in Table 2 that the percentage of correct answers is very low in all grades, however a small increase can be found in grade 9. Also, in contrast to *Sanger's* findings, the ratio of the methods B3 (X1) and B4 (X2) to the others is very small. It is remarkable that the frequency of usage for method B6 increases with the grade. Among the Hungarian students the typical unsuccessful strategy changes according to the grades in the order of B2 → B5 → B4 → B5 → B6. Because of the small percentage of these strategies their change does not lead to a change in the students' overall knowledge structure.

Chemical Composition of Matter

As was noted in the introductory part of this paper, in 1986 *Briggs and Holding* prepared particulate diagrams of a mixture of two elements, a compound and an element alone. Using this test *Briggs and Holding* (1986), *Barker* (1995) as well as *Laverty and McGarvey* (1991) studied the understanding of element and compound among secondary-school (13-18 year old) students in the UK. They found that about 30% of respondents identified all three pictures correctly.

Secondary school students in Hungary are less successful in the classification of *Sanger's* drawings (Figure 7). The average percentage of correct answers was 39.4%, and only 0.9-2.4% of the students identified all

five drawings correctly (Table 3). It is noted that the average percentage of correct answers was 69.2% for *Sanger's* students (*Sanger*, 2000).

Figure 7 also shows that, similarly to *Sanger's* results, our students identified picture 3 (as an element) easily, but the classification of picture 4 as elements was the hardest question for them.

According to the analysis of variance there is no significant difference between the scores of 8-9th ($p = 1.000$), and 9-10th ($p = 0.422$) graders. We obtained significant differences between 7th and 10th ($p = 0.000$), 7th and 11th ($p = 0.025$), 8th and 10th ($p = 0.062$) as well as 9th and 10th ($p = 0.060$) graders. These data mean that there is a significant increase in the performance in 8th and 10th grades. (Note that similar results were obtained from the statistical analysis of the overall test and the sub-test 'state of matter'.)

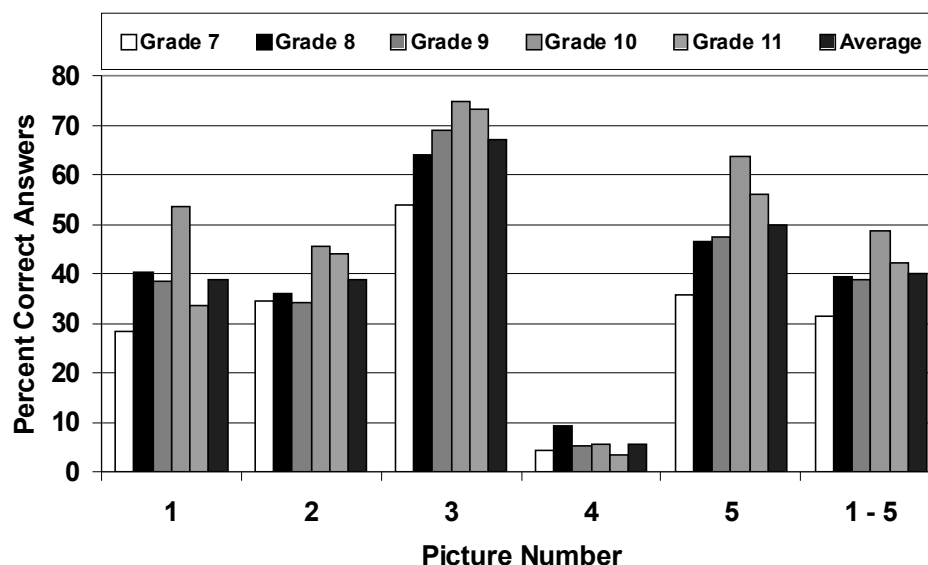
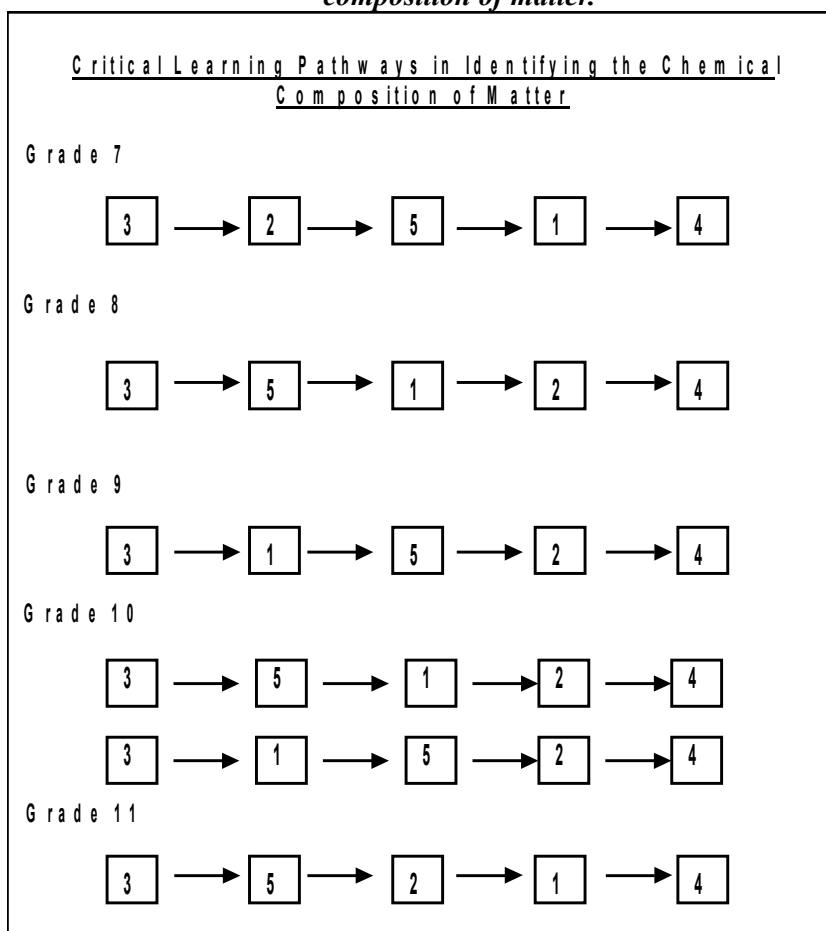

Figure 7. Results for students in identifying picture 1-5 according to the chemical composition of matter.

There are small changes in the critical learning pathways in every grade (Figure 8). It is seen that the concept of pure element (picture 3) is the most reliable part of the cognitive structure, and the knowledge needed to classify the mixture of elements (picture 4) is very unstable. In general the identification of pure substances (pictures 3 and 5) occurs early in this hierarchy, while the classification of mixtures is situated at the end of the critical learning pathways. It is also noticeable that the critical learning pathways for 8th and 10th graders are the same. (Remember that there were significant increases in the scores at these grades, too.)

Table 3 contains the main classification methods identified from students' responses. Students applying method C1 classify pictures by a 'visual' strategy. Pictures containing only one type of symbol represent an element (picture 3); in another case they identify the drawing as a compound (pictures 1, 2, 4 and 5).

Figure 8. Critical learning pathways in identifying the chemical composition of matter.



In method C2 students distinguish between elements and compounds correctly (pictures 3 and 5). However, they think that elements and compounds should always be pure substances, therefore they put all other combinations (mixtures) into the category 'both' (pictures 1, 2 and 4).

Unfortunately it could not be determined how students working with method C3 identified pictures 2 and 4 as compounds.

Strategy C4 is very similar to strategy B5 identified in respect of the physical composition of matter. Students categorize drawings according to the diversity of symbols in the picture. One kind of symbol represents an element (picture 3), two kinds of symbols represent compounds (pictures 4 and 5), whilst three kinds of symbols represent elements and compounds (pictures 1 and 2).

Table 3. Classification Methods Identified from Students' Written Responses (The Chemical Composition of Matter)

Method	Students' Response Elements / Compounds / Both	Percentage of Responses in Grades*				
		7 n=163	8 n=161	9 n=135	10 n=127	11 n=116
C1	3 / 1,2,4,5 / -	0.6%	1.2%	3.7%	4.7%	5.2%
C2	3 / 5 / 1,2,4	6.1%	6.2%	5.9%	12.6%	7.8%
C3	3 / 2,4,5 / 1	3.7%	9.3%	9.6%	7.1%	6.9%
C4	3 / 4,5 / 1,2	5.5%	9.3%	6.7%	14.2%	7.8%
C5	3 / 1,5 / 2,4	1.8%	3.1%	5.2%	4.7%	6.0%
Correct	3,4 / 5 / 1,2	1.2%	1.9%	1.5%	2.4%	0.9%
	Other complete	21.5%	17.9%	24.5%	20.5%	24.8%
	None	34.4%	19.9%	20.7%	9.4%	14.7%
	Incomplete	25.2%	31.2%	22.2%	24.4%	25.9%

*The percentage of the most frequently used methods is highlighted in bold.

In method C5 the diversity and the arrangement of the symbols in the picture is the starting point of the classification similar to the method B6. One kind of symbol represents an element (picture 3), well-arranged different symbols represent a compound (pictures 1 and 5), and several kinds of symbols chaotically arranged are a mixture of elements and compounds (pictures 2 and 4).

It is noticeable that method C4 is characteristic of the 8th, 10th and 11th graders. However methods C1 and C5 are not characteristic at any grades; their increase according to grade suggests that, in the case of unsuccessful students, formal strategies precede conceptual strategies (e.g. method C2).

Conclusions

Our research has shown that Sanger's particulate drawings are suitable for studying 13-17 year-old students' understanding of physical and chemical composition as well as the state of matter, even in a situation where the Hungarian students are not familiar with handling this type of particulate diagrams.

Based on our results we can answer the research questions posed in the early part of this paper as follows:

1. Hungarian secondary school students are quite successful in identifying the state of matter, especially in the case of solid samples. However they have serious problems in distinguishing between homogeneous and heterogeneous mixtures. Furthermore we found evidence that most of them do not understand the difference between the physical composition (pure substance or mixture) and chemical composition (element or compound) of matter.
2. Among the students' responses we could identify some typical classification methods applied by unsuccessful students. Most of these strategies are based on simple visual and formal inspection of drawings (seeing any differences, counting how many kinds of symbols there are, evaluating the arrangement of the symbols etc.). Conceptual methods giving incorrect responses generally involve misunderstandings and mixing the macroscopic and sub-microscopic interpretations. The following misconceptions can be found:
 - (i) water always exists in the liquid phase;
 - (ii) particles of gases should be the same;

- (iii) particles in solid samples should be organized in the same repeating pattern;
 - (iv) elements and compounds always exist as pure substances;
 - (v) in heterogeneous mixtures particles of different types must not be evenly distributed.
3. Using knowledge-space theory as a tool for structural analysis we could not find long-lasting changes in the students' cognitive structure. Only slight and temporary changes can be observed in grade 9 (in identifying the state of matter), in grade 8 (in identifying the physical composition of matter, and in identifying the chemical composition of matter).
 4. On the basis of the results of statistical, content and structural analysis we can conclude that a slight development in understanding of these basic concepts can be observed in grades 8 and 10. Note that in Hungary students study mainly inorganic chemistry in grade 8, and mainly organic chemistry in grade 10. This fact suggests that investigation of real chemical systems and the explanation of their nature perhaps are more effective for success in identifying particulate drawings and for the interpretation of the nature of matter at sub-microscopic level than studying general chemistry alone.

We also demonstrated that the evaluation of data at three levels (statistical analysis, content analysis and structural analysis) provides clearer and more reliable information about the conceptualization and cognitive organization of students' knowledge.

Acknowledgments

This work was supported by the Hungarian Scientific Research Fund (OTKA T-034288 and T-049379). We thank *Mare Taagepera* (University of California at Irvine) for their help in preparing this paper. We also thank *Gaelan Lloyd* (University of California at Irvine) for giving us free trials in using hDA, and *László Zékány* (University of Debrecen) for reviving the simplified version of KST Basic program.

References

- ARASASINGHAM, R. D.; TAAGEPERA, M.; POTTER, F.; LONJERS, S. (2004): *J. Chem. Educ.* 81, 1517-1523.
- ARASASINGHAM, R. D.; TAAGEPERA, M.; POTTER, F.; MARTORELL, I.; LONJERS, S. (2005): *J. Chem. Educ.* 82, 1251-1262.
- BARKER, V. (1995): A longitudinal study of 16-18 year olds' understanding of basic chemical ideas; D. Phil. Thesis; Department of Educational Studies; University of York; York. Cited in Barker V. *Beyond Appearances: Students' Misconceptions about Basic Chemical Ideas*; Royal Society of Chemistry; London, 2003; p 21.
- BRIGGS, H.; HOLDING, B. (1986): Aspects of secondary students' understanding of elementary ideas in chemistry: Full report. Children's learning in science project; University of Leeds; Leeds. Cited in Barker V. *Beyond Appearances: Students' Misconceptions about Basic Chemical Ideas*; Royal Society of Chemistry; London, 2003; p 20.
- DOIGNON, J.-P.; FALMAGNE, J.-C. (1999): *Knowledge Spaces*; Springer-Verlag; London.
- GABEL, D. L.; SAMUEL, K. V.; HUNN, D. (1987): *J. Chem. Educ.* 64, 695-697.
- JOHNSON, P. (1998): *Int. J. Sci. Educ.* 20, 393-412.
- LAVERTY, D. T.; MCGARVEY, J. E. B. (1991): *Educ. Chem.* 28, 99-102.

LLOYD, G. <http://hda.gaelanlloyd.com>
NAKHLEH, M. B. (1993): *J. Chem. Educ.* 70, 52-55.
NURRENBERN, S. C.; PICKERING, M. (1987): *J. Chem. Educ.* 64, 508-510.
POTTER, F. <http://chem.ps.uci.edu/~mtaagepe/KSTBasic.html>
SANGER, M. (2000): *J. Chem. Educ.* 77, 762-766.
SANGER, M. J. (2005): *J. Chem. Educ.* 82, 131-134.
STAVY, R.; STACHEL, D. (1985): Children's ideas about 'solid' and 'liquid'. *Eur. J. Sci. Educ.* 7, 407-421. Cited in Barker V. *Beyond Appearances: Students' Misconceptions about Basic Chemical Ideas*; Royal Society of Chemistry; London, 2003; p 6.
TAAGEPERA, M.; ARASASINGHAM, R. D.; POTTER, F.; SOROUDI, A.; LAM, G. (2002): *J. Chem. Educ.* 79, 756-762.
TAAGEPERA, M.; NOORI, S. (2000): *J. Chem. Educ.* 77, 1224-1229.
TAAGEPERA, M.; POTTER, F.; MILLER, G. E.; LAKSHMINARAYAN, K. (1997): *Int. J. Sci. Educ.* 19, 283.
TABER, K. (2002): *Chemical Misconceptions – Prevention, Diagnosis and Cure*; Vol I-II; Royal Society of Chemistry; London.
Zoller, U.; Lubezky, A.; Nakhleh, M. B.; Tessier, B.; Dori, Y. J. (1995): *J. Chem. Educ.* 72, 987-989.